

# Air Monitor

DOE HQS. Document Search: March 1983  
 COLLECTION: Los Alamos Records Center  
 Group: H-8 COPIED/DOE Loc: F-23  
 LANL RC B-195

## Redwing

### Log of Environment Fallout

### Monitoring East.

# SINGLE ENTRY LEDGER

*W. Starnes 11-29-83*



12/15  
56-July '56

etc. may be found inside

3.38 x 10<sup>5</sup>

1

1.5 x 10<sup>5</sup>

1.3 x 10<sup>5</sup>

3.75 x 10<sup>5</sup>

23

Date	Location	Notes
19		
20		
21	COPIED/DDE LANL HC	
22		
23		
24		
25		
26		
27	COPIED/DDE LANL HC	
28		
29		
30		
1	July '56	
2		
3		
4		
5		
6		
7		
8		
9		
10		
11		
12	COPIED/DDE LANL HC	
13		
14		
15		

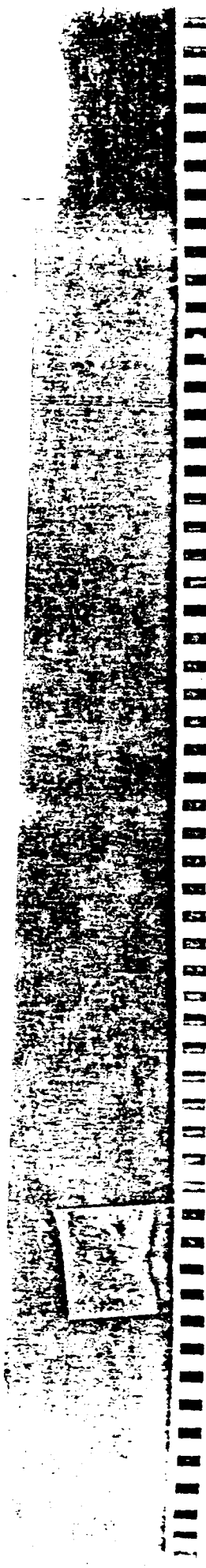

5.75 x 10<sup>5</sup>

3 x 10<sup>4</sup>

COPIED/DOE  
LAW RC

- 11
- 12
- 13
- 14
- 15
- 16
- 17
- 18
- 19
- 20
- 21
- 22
- 23
- 24
- 25
- 26
- 27

2.48 x 10<sup>6</sup>

21 July proper date  
proper date

1.1 x 10<sup>5</sup>

22 July

COPIED/DOE  
LAW RC

# General Data

Operation began:

Elmer sampler	-	24 May 1956
Ainsworth "	-	29 May 1956
Sta. # 70 "	-	29 May 1956

All three units were calibrated at the shop (Elmer) before being put in operation. A calibration chart will be found in the rear of this record. The units were found to be quite linear for evenly spaced pulses.

The following may be used to calculate the number of cubic feet of air whose residue is seen by the detector at any given time.

$$N = 3.06 \frac{A}{B}$$

where:

N = number of cubic feet  
A = air flow rate, ft<sup>3</sup>/minute  
B = filter paper speed, ft/hour

Detector efficiency values taken using the sources supplied with the unit follow.

COPIED/DOE  
LASL RC

Source	EFFICIENCY (%)
$2.22 \times 10^5$	11.25 - 10.45
$5.57 \times 10^5$	9.72 - 7.65
$1.11 \times 10^6$	<del>7.76</del> - 1.06

The above figures were arrived at by using a scaler to count monitor's pulse shaped but unintegrated output. No attempt to show coincidence loss etc. was made.

### Conversion Factor

$$\begin{aligned}
 d/m/meter^3 &= (\text{net count}) \left( \frac{1}{\epsilon_{pp}} \right) \left( \frac{1}{t^3} \right) \left( \frac{t^3}{m^3} \right) \\
 &= c/m \times d/c \times \frac{1}{t^3} \times \frac{t^3}{m^3} \\
 &= c/m (8.9) (1/2.7) \times 34.3 \\
 &= c/m (113)
 \end{aligned}$$

It is felt however that the efficiency is considerably higher at low levels than indicated, a conversion factor of 75 was used in all works.

cont.

The resolution time of the instrument at a tape speed of one foot per hour is about 12 minutes. Many of the 'spikes' appearing on the records were undoubtedly caused by one or two hot particles. Filter tape cutting proved this to be true in a small number of cases checked.

There is also a lag of from 20 - 30 minutes @ 1 ft/hr. filter speed between sampling time and counting. In high level cases the rise in back ground may signal the operator to increase the tape speed and shorten the time lag.

COPIED/DOE  
L. H. RC

67

## Recommendations

The size and weight of the present air monitors is very unhandy for field use. The necessity of oiling every two days is also not suited to a unit which may be removed in the field. The filter tape re wind clutch does not work well and mechanical over load protection should be provided for the drive transmission. The Anton Laboratory 100-IT alpha-beta tubes claim low background and due to their small length to diameter ratio would reduce the pig size considerably. It is hoped that the logarithmic amplifier originally planned for the monitors may be incorporated - if not then remote scale selection is necessary.

COPIED/DOE  
LANL RQ



## Rain & Fallout

It was noticed toward the end of the operational period that rain was often followed by periods of fall out. Rain information was obtained from the weather station on Fred. How closely the start and stop times coincide for the two islands is not known. Cases of coincidence are shown on the summary at the front of the record and covered more carefully at the rear.

No record of rainfall has been procured for Bikini Atoll.

After procurement of the data it was noted that both the amount of data and accuracy of readings did not lead themselves to a detailed correlation. It is not difficult to conjecture that if various layers of air above us are somewhat active - that rain will or perhaps will bring a certain amount of it down - It is believed that that may be taken as conclusion for this brief attempt. The data is enclosed hoping that further information may prove useful.

# NAN

Time base

- 2 divisions per hour

Scale

- reads directly in counts per minute times the scale factor

range      scale factor.

1K - X 100

10K - X 1000

100K - X 10,000

The small conversion rule to be found at the beginning of this record will enable quick conversion to  $1/m^3$  using a factor of 75. (Discussed earlier)

COPY/DOE  
LANE RG

07

AVERAGE BACKGROUND

29 MAY - 1300 TO 2300

100 c.p.m.

4.5

1340

1730

2710

← 1900 29 MAY

1790

1710

← 1700 29 MAY

← 1625 29 MAY

← 1600 29 MAY

← 1530 29 MAY

1500

1445

1430

1345

← 1315

1245

1130 29 May

1030

← 945 AM 29 MAY

945 AM 29 May

gilt. No. indicates 29

No count  
Service Machine

10

30 May 1956  
3

BACKGR

NO COUNT  
AFTER

MONITOR  
MAY 30

WARM U  
1355 T

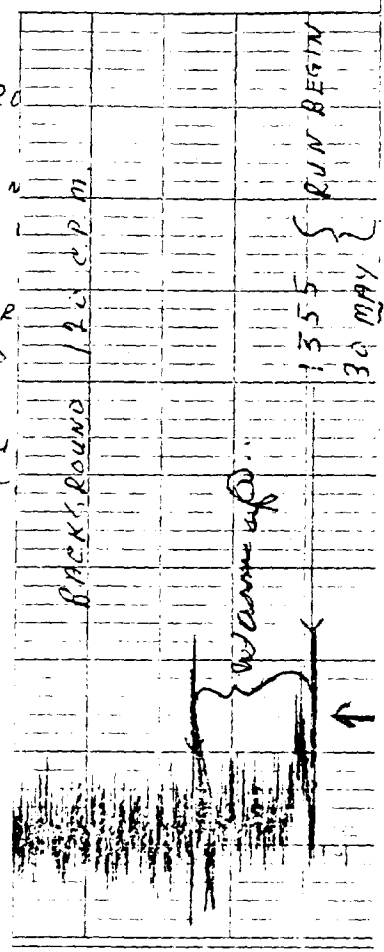

COPIED/DOE  
L. H. H. G.

11

12

61

31 MAY 1950

5

← 190 C.P.M.  
1600-31 MAY

← 140 C.P.M.  
1450-31 MAY

← 160 C.P.M.  
1205-31 MAY

← 220 C.P.M.  
1121-31 MAY

← 1021 AM ~~From~~ 31 MAY

25 up & down

← 350 C.P.M. 1010 31 MAY  
1000

← 350 C.P.M. 0945 31 MAY  
31 MAY

← 420 C.P.M.  
0832  
31 MAY

0810 C.P.M. SCALE ON  
31 MAY 1K RANGE FOR  
12 MINUTES.

← 190 C.P.M. 0502  
31 MAY

← 180 C.P.M. 0435  
31 MAY

COPIED/DOE  
LANL RG

12

13

TIME					
		BACKGROUND - 100 c.p.m.			
0435		180 c.p.m.			
0502		190 c.p.m.			
0810		OVER 1000 c.p.m.			
0832		470 c.p.m.			
0945		350 c.p.m.			
1030		350 c.p.m.			
		1012 TO 1021 ADJUSTING RECORDER			
1121		220 c.p.m.			
1205		160 c.p.m.			
1450		140 c.p.m.			
1600		190 c.p.m.			

COPIED/DUE  
LANL RG

134

MADE IN U.S.A.

← 550 C.P.M.  
1910 JUNE 1

← 1730 JUNE 1

← 190 C.P.M.  
1610 JUNE 1

← 140 C.P.M.  
1535 JUNE 1

← 1215 1 JUNE  
~~← 1215 PM 1 JUNE~~

~~XXXXXXXXXX~~

Adjust:

← 1210 PM 1 June

← 1140 AM 220 C.P.M.

COPIES/LOGS  
LAW 10

← 250 C.P.M.

← 1010 AM  
950 AM

1 June

← 340

14  
15

BACKGROUND - 80 c.p.m.

0950 360 c.p.m.

1010 280 c.p.m.

1140 220 c.p.m.

1210 TO 1215 ADJUSTING RECORDER

1535 180 c.p.m.

1610 190 c.p.m.

1910 550 c.p.m.

2350 380 c.p.m.

COPIED/DCG  
LAHL RG

15



← 560 C.A.M.  
1605 JUNE 2

← 1500 JUNE 2

← 140 C.P.M.  
1330 JUNE 2

← 340 C.P.M.  
1255 JUNE 2

← 140 C.P.M. 0855  
0845 AM 2 JUNE

← 800 P  
0710 JUNE 2

← 0330 JUNE 2

16

BACKGROUND - 80 c.p.m.

0240 660 c.p.m.

0710 800 c.p.m.

0855 140 c.p.m.

1255 340 c.p.m.

1330 140 c.p.m.

1605 560 c.p.m.

1920 240 c.p.m.

2320 130 c.p.m.

17  
PAGE

← 370 JUNE 3

← 340 C.P.M.  
0705 JUNE 3

← 0315 JUNE 3

← 200 C.P.M.  
0115 JUNE 3

CORP/DOE  
1871 RC

← 240 C.P.M.  
0025 JUNE 3

← 410 C.P.M.

BACKGROUND - 80 c.p.m.

0010 440 c.p.m.

0025 240 c.p.m.

07:5 340 c.p.m.

1530 120 c.p.m.

CONFIDENTIAL

4 JUNE 1956 13

BACKGROUND - 70 C.P.M.

1901 140 C.P.M.

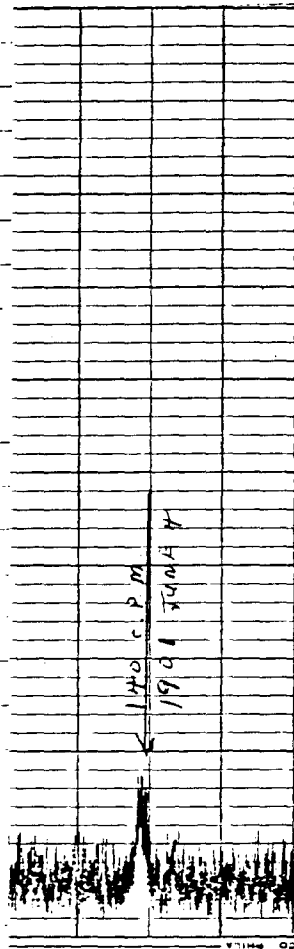

COPIED/DOE  
LANL RC

20

6 JUNE 1956 17

BACKGROUND - 60 c.p.m.

1332

120 c.p.m.

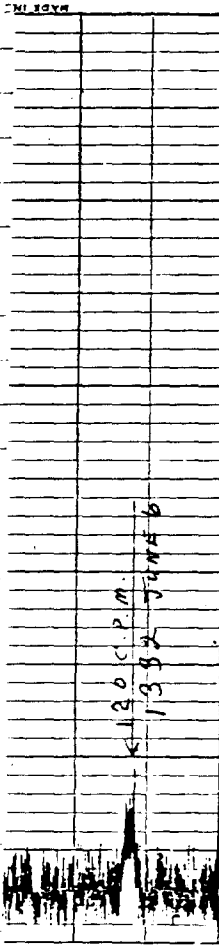

COPIED/30E  
LAIL PC

13

5 JUNE 1956 15

BACKGROUND - 60 c.p.m.

NO COUNTS ABOVE BACKGROUND

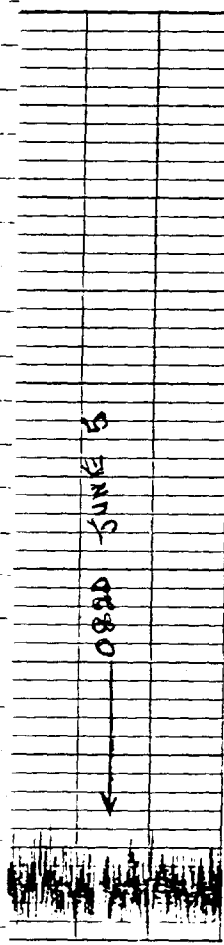

COPIED/DOE  
LANL RC

21

BACKGROUND - 55 C.P.M.

NO COUNTS ABOVE BACKGROUND

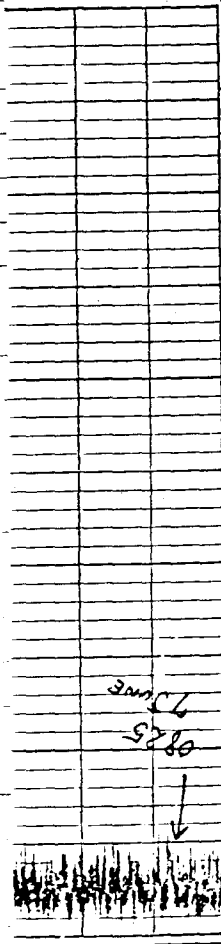

COPIED/DOE  
LANL RC

23



8 JUNE 1956 21

BACKGROUND - 50 c.p.m.

NO COUNTS ABOVE BACKGROUND.



COPYED/QUE  
LAIL AG

24

BACKGROUND - 50 C.P.M.

NO COUNTS ABOVE BACKGROUND.

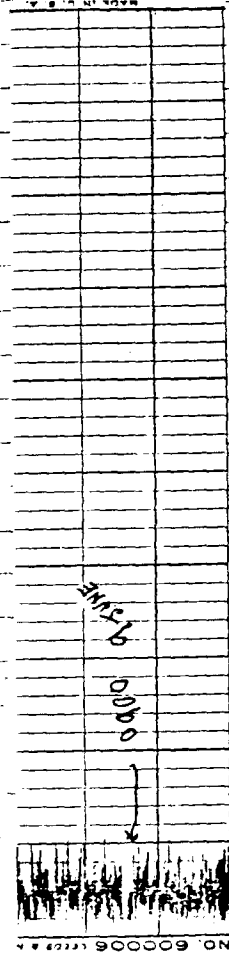

COPIED/DOE  
LANL RC

25

10 JUNE 1956 25

BACKGROUND - 50 C.P.M.

1652

80 e.p.m.

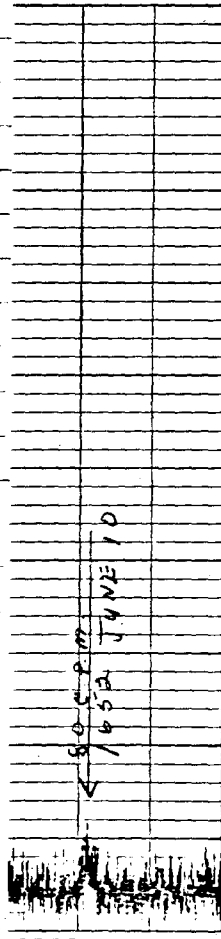

COPIED BY  
LAWL RC

26

BACKGROUND - 40 c.p.m.

1355

280 c.p.m. (CHECK GRAPH)

(They have been automatic recorder balance)

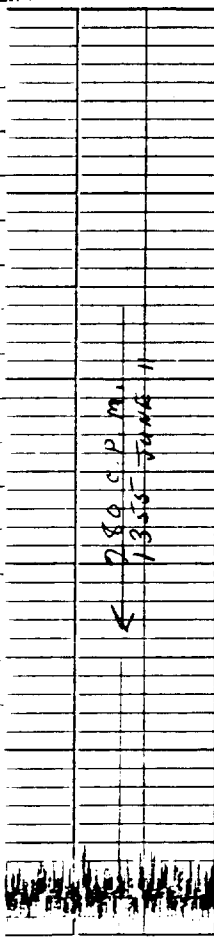

COPIED/DOE  
LANL RG

27

12 JUNE 1956 29

BACKGROUND - 40 C.P.M.

NO COUNTS ABOVE BACKGROUND.

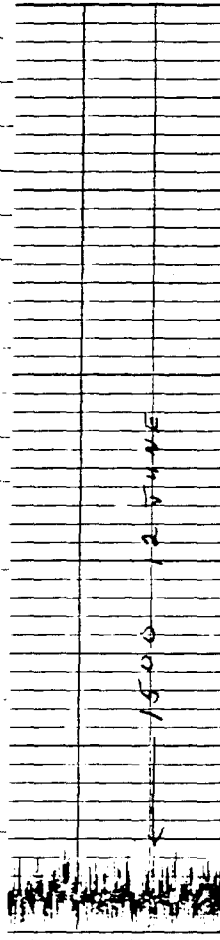

COPYED/VE  
LAVL PC

28

← 180 C.P.M. - 1506 JUNE 13

← 70 C.P.M. - 1250 JUNE 13

← 180 C.P.M. - 1232 JUNE 13

← 120 C.P.M.  
1209 JUNE 13

← 140 C.P.M. - 1033 JUNE 13

← 130 C.P.M. - 1010 JUNE 13

← 1020 JUNE 13

← 90 C.P.M.  
1003 JUNE 13

OFF SCALE ON  
1/2 K RANGE  
(1105 JUNE 13)

← 0940  
139

← 110 C.P.M. - 0737 JUNE 13

← 80 C.P.M. - 0720 JUNE 13

← 120 C.P.M.  
0539 JUNE 13

← 100 C.P.M.  
0428 JUNE 13

COPIED  
L.M.L. RC

← 120 C.P.M. - 0224 JUNE 13

← 100 C.P.M. - 0210 JUNE 13

← 120 C.P.M.  
0140 - JUNE 13

211

BACKGROUND - 30 C.P.M.

0140	120 C.P.M.
0210	100 C.P.M.
0224	120 C.P.M.
0428	100 C.P.M.
0539	120 C.P.M.
0720	80 C.P.M.
0737	110 C.P.M.
1003	90 C.P.M.
1020	130 C.P.M.
1033	140 C.P.M.
1105	OVER 1000 C.P.M. (CHECK GRAPH)
1204	120 C.P.M.
1232	180 C.P.M.
1250	170 C.P.M.
1506	180 C.P.M.

COPIED

DOE  
LANL RC

30

← 150 C.P.M.  
2318 JUNE 14

← 180 C.P.M.  
2103 JUNE 14

← 120 C.P.M.  
1936 JUNE 14

← 180 C.P.M.  
1946 JUNE 14

← 160 C.P.M. - 1444 JUNE 14

← 140 C.P.M.  
1430 JUNE 14

← 150 C.P.M.  
1342 JUNE 14

← 500 C.P.M.  
1309 JUNE 14

← 120 C.P.M.  
1145 JUNE 14

COPIED/DOE  
LAWL FC

31



BACKGROUND - 80 c.p.m.

1145	120 c.p.m.
1309	500 c.p.m.
1342	150 c.p.m.
1430	140 c.p.m.
1444	160 c.p.m.
1846	180 c.p.m.
1936	120 c.p.m.
2103	180 c.p.m.
2318	150 c.p.m.

COPIED/DOE  
LANL RC

32

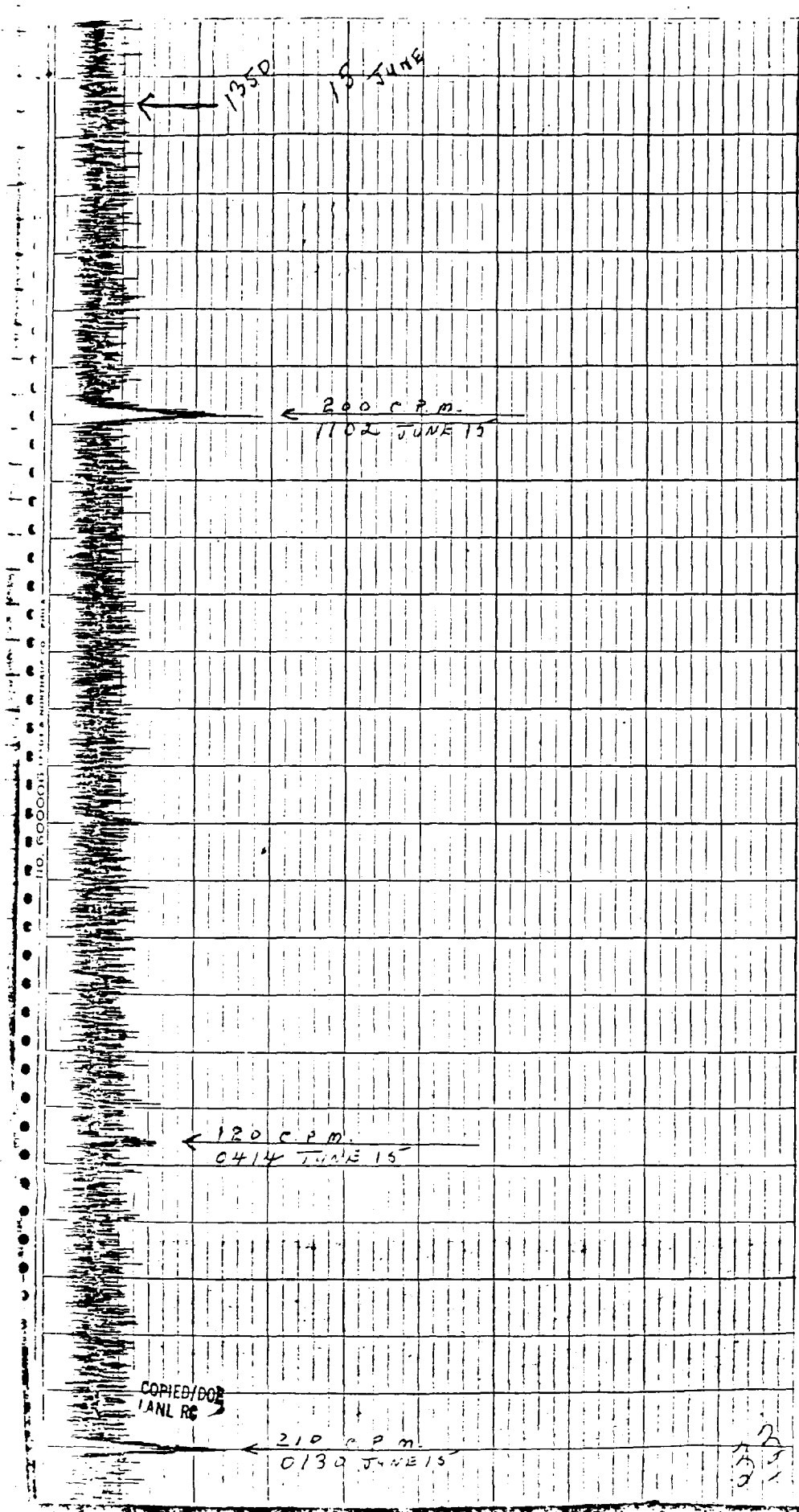

1350 18 JUNE



200 C.P.M.  
1102 JUNE 15

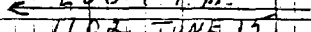

120 C.P.M.  
0414 JUNE 15

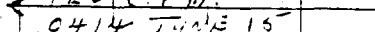

COPIED/DOE  
/ANL RC

210 C.P.M.  
0130 JUNE 15

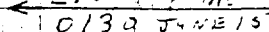

2  
15  
1

BACKGROUND - 70 C.P.M.

0130	210 C.P.M.
0414	120 C.P.M.
1102	200 C.P.M.

COPIED/DOE  
LANL RC

34

16 JUNE 1956 37

BACKGROUND - 70 C.P.M.

NO COUNTS ABOVE BACKGROUND.

MONITOR WAS TURNED  
OFF AT 1500 JUNE 16  
TO 0845 JUNE 17.

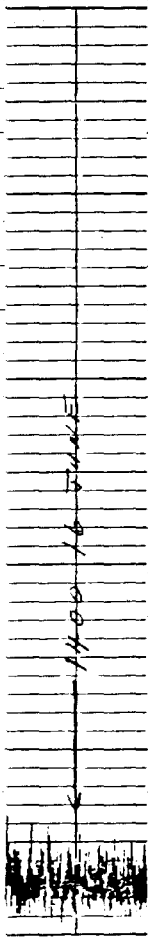

COPIED/DOE  
LANL RG

35

BACKGROUND - 60 C.P.M.

0845 MONITOR WARM UP FOR 45 MINUTES

1671 230 C.P.M.

1720 160 C.P.M.

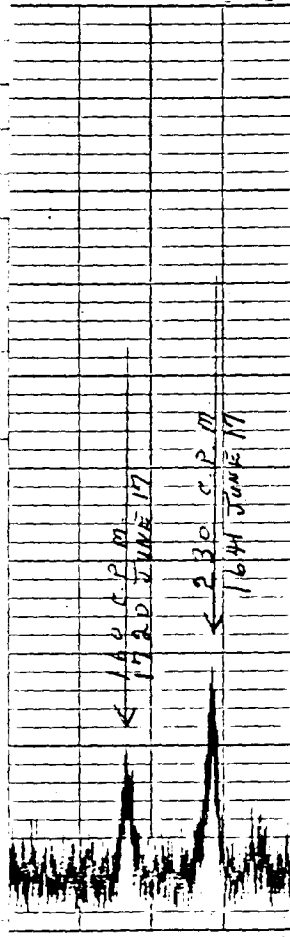

COPIED/DOE  
LANL RG

36

BACKGROUND - 60 C.P.M.

NO COUNTS ABOVE BACKGROUND

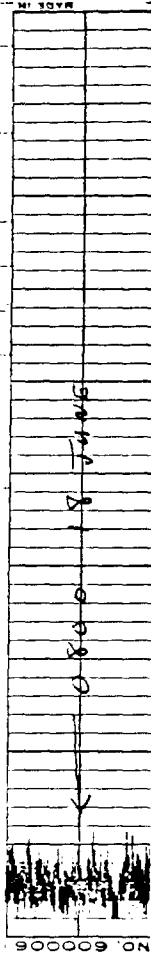

COPIED/DGE  
LANL RG

19 June 1956

40

DIP ED/DOE  
L341L RG

38

20 June

45

The image shows a large grid with a smaller grid inset. The large grid has approximately 18 columns and 25 rows. The smaller grid is located in the lower-left quadrant of the large grid, measuring about 4 columns by 18 rows. The grid lines are thin and evenly spaced.

COPYED/DDE  
AND RC

COPYED/DDE  
AND RC

39





27 June 49

The image shows a sheet of graph paper with a grid pattern. A vertical strip of smaller graph paper is pasted onto the main sheet, positioned in the lower-left quadrant. The strip is oriented vertically and contains a grid of approximately 20 rows and 2 columns. The main sheet has a grid of approximately 20 rows and 10 columns. The grid lines are thin and light gray.

COPIED BY  
JANL RC

41

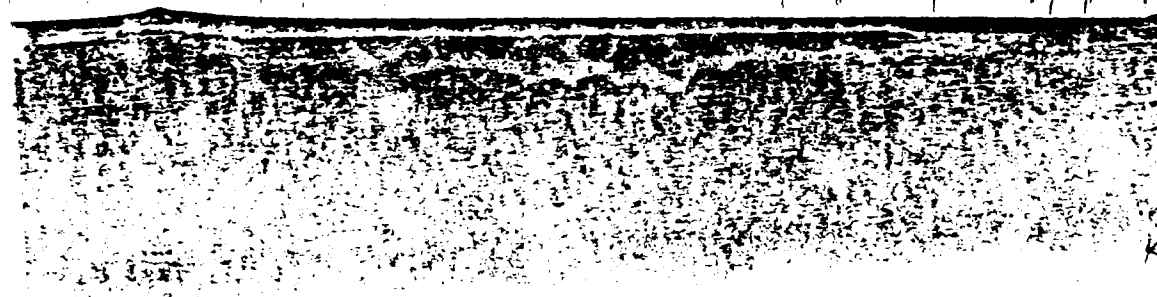



Table with a grid of approximately 12 columns and 25 rows. A vertical column of small rectangular cells is present in the lower-middle section of the grid. The rest of the grid is mostly empty.

COPIED/DOE  
LANL RG

44











29 June 63

COPIED/DOE  
LANL RC

48





2 July 69

The image shows a large sheet of graph paper with a grid. A vertical strip of smaller graph paper is pasted onto the main grid, positioned roughly in the middle horizontally and extending from the top to the bottom of the main grid. The strip is narrower than the main grid's columns. The grid lines are clearly visible and form a consistent pattern across the page.

COPIED/DOE  
LANL RQ

NO. 50

51



4 July 73

The image shows a large sheet of graph paper with a grid of squares. In the center of the page, there is a vertical strip of smaller graph paper, also with a grid pattern, pasted onto the main sheet. The grid lines are thin and black. The paper appears to be from a notebook or a set of loose-leaf paper. There are some dark smudges or ink marks at the bottom of the vertical strip.

COPIED/DOE  
LANL RG

53

5 July 75

A vertical column of approximately 25 small, illegible handwritten entries, possibly representing a list or a series of data points. The entries are too small to be read but appear to be organized in a structured manner within the grid.

COPIED/DOE  
LANL RQ

54

COPIED/DOE  
LAHL RC

55  
1





8 July 81

NO. 60006 1208 A

2531

2532

COPIED/DOE  
LAHL RC

57



COPIED/DOE  
LANL RC ✓

59





COPIED/DDE  
LANL RC

11/60  
A. J. W. J.  
1956

COPIED/DDE  
LANL RC

63

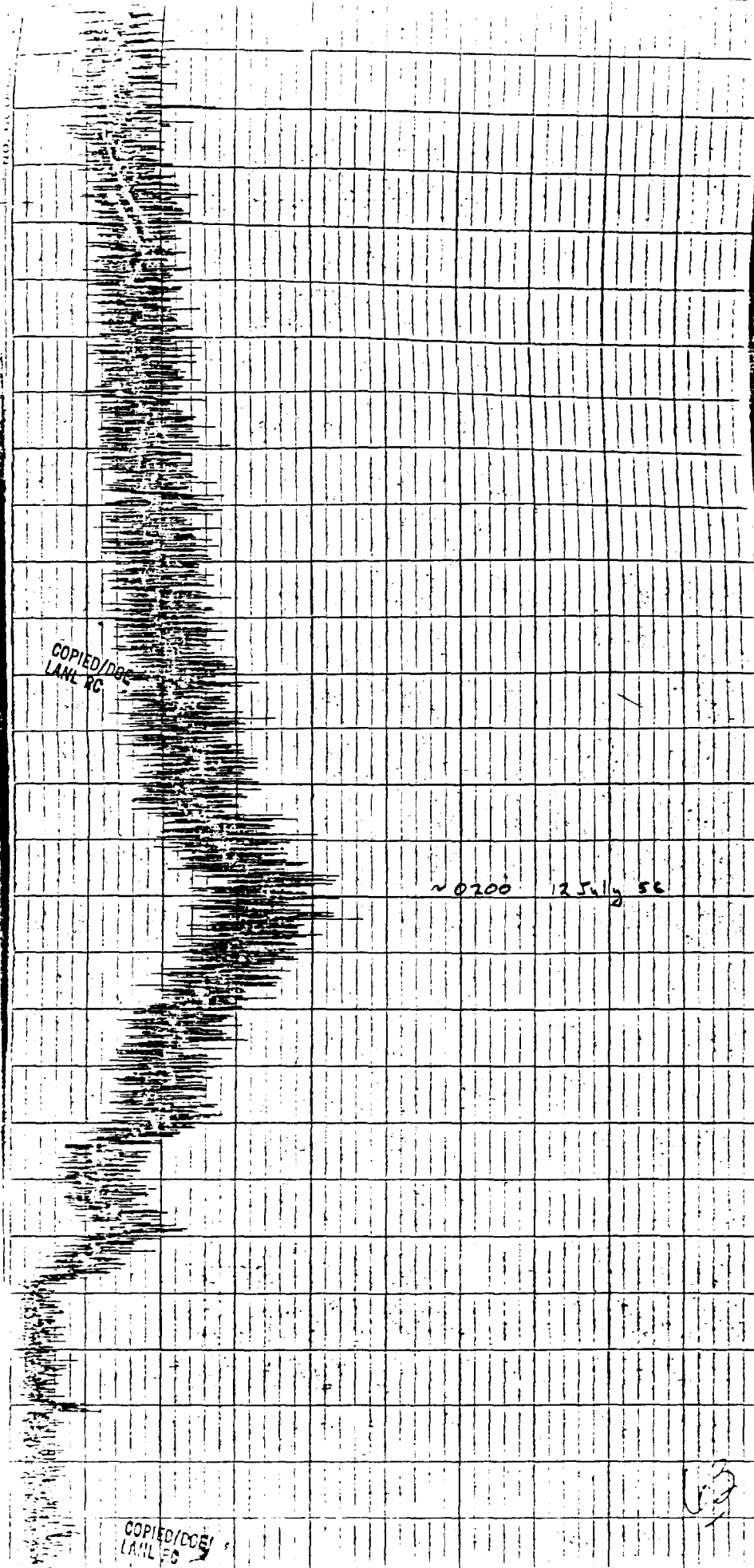

COPIED/DOE  
LANL KC

~ 0200 12 July 56

COPIED/DOE  
LANL KC

U3



13 July 91

A vertical strip of a grid, approximately 2 columns wide and 40 rows high. The bottom portion of the strip is obscured by a dense, dark, noisy pattern, likely an artifact from the scanning process or a redaction.

COPIED/DOE  
LANL RC

64

14 July 93

1978
1979
1980
1981
1982
1983
1984
1985
1986
1987
1988
1989
1990
1991
1992
1993
1994
1995
1996
1997
1998
1999
2000
2001
2002
2003
2004
2005
2006
2007
2008
2009
2010
2011
2012
2013
2014
2015
2016
2017
2018
2019
2020
2021
2022
2023
2024
2025
2026
2027
2028
2029
2030

1978  
1979  
1980  
1981  
1982  
1983  
1984  
1985  
1986  
1987  
1988  
1989  
1990  
1991  
1992  
1993  
1994  
1995  
1996  
1997  
1998  
1999  
2000  
2001  
2002  
2003  
2004  
2005  
2006  
2007  
2008  
2009  
2010  
2011  
2012  
2013  
2014  
2015  
2016  
2017  
2018  
2019  
2020  
2021  
2022  
2023  
2024  
2025  
2026  
2027  
2028  
2029  
2030

COPIED/DOE  
LANL RC

65



16 July 97

WAXM UP PROL ↑

Machine - trouble - done  
gears

COPIED/DQE  
LNL RC

67

17 July 99

COPIED/DOE  
LANL RQ

68



19 July

103

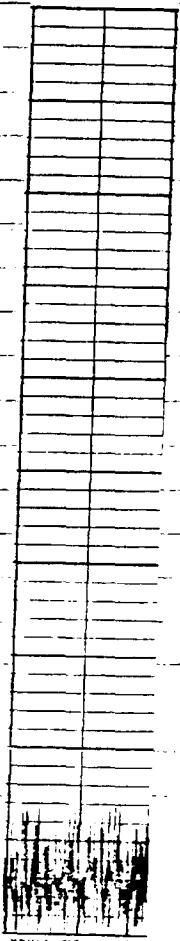

ORTHOGONAL CO. PHILA.

COPIED/DOS  
LANL RG

70

IMRC

COPIED/DOE  
LANL RC

71

72



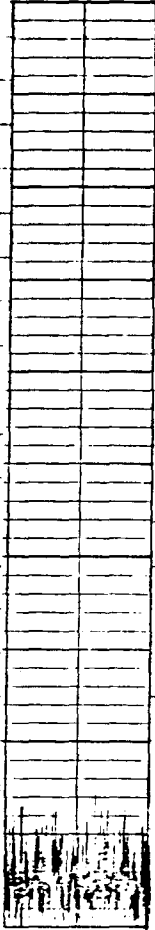

COPIED/DOE  
LAWL RC

72

COPIED/DQS  
LANL RC

13

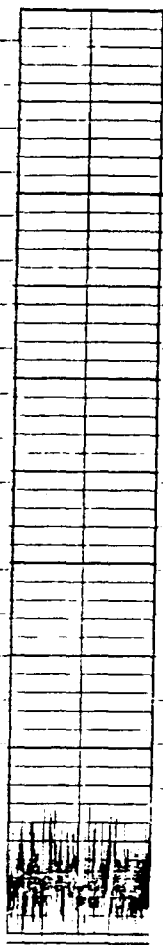

COPIED/DOE  
LANL RC

44

COPIED/DOE  
LANL RC

OS ON

15

ELMER

#

Ty

bae

The

of +

COPI

76

#1

Typical source  
back grounds during  
the earlier portion  
of the operation  
D&R 1 curie →

COPIED BY  
LIFE 90

#1

#2

cont. from #1

J-Div 287 curie →

COPIED BY

located about 120 yds

78

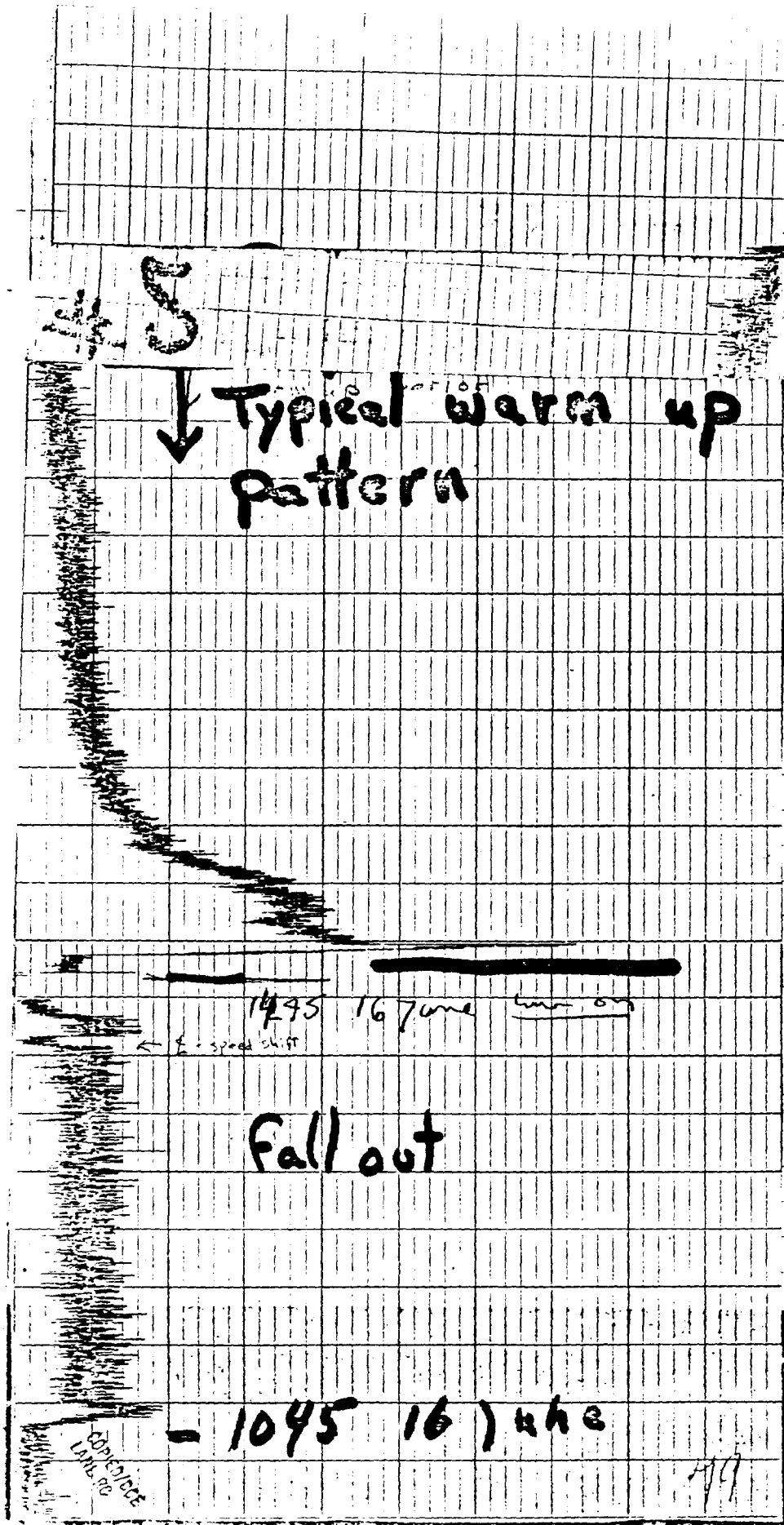

S

↓ Typical warm up pattern

1495 16 June  
← speed shift

Fall out

- 1045 16 June

8070102E  
LATE 90



APX 1 AM May 25

0100 25 MAY

MAX  $8.2 \times 10^4$  d/h/m<sup>3</sup>

MA

APX 2000 24 MAY

COPIED/COP  
L. L. RQ

COPIED/COP  
L. L. RQ

APX 7:30 PM 24 May

1930 24 MAY

wind up

9

1625 24 MAY

operate  
WARM UP

0710 29 May 56

0710 29 May 56

2 3 5 1 2 3 5 1 2 3 5 1 2 3 5 1

COPIES 2400 28 May 56

3 5 1 2 3 5 1 2 3 5 1 2 3 5

82

Rain 1850-1903

RAIN  
1700

approx  
1600 = 28 MAY

MAX.  $9.5 \times 10^9$  d/m<sup>3</sup>

COPIED/DOE  
LAWL RC

071028 May 56

1930 29 May

COPIED FOR  
L. L. B.

1550 29 May

MAX  $2.4 \times 10^4$  d/m/m<sup>3</sup>

0710 29 May 56

0710 29 MAY 56

84

29 May 1550, 1930, 0030  
hi back ground beta count

5 1 2 3 5 1 2 3 5 1 2 3 5 1

1930 29 May

COPIED/DOB

3 5 1 2 3 5 1 2 3 5 1 2 3 5

1550 29 May

6

MAX  $2.4 \times 10^4$  d/m/m<sup>3</sup>

COMING 1600 WIND 2350

COPIED/DOE  
LANL RG

1215 30 MAY

MAX  $1.95 \times 10^4$  d/m/m

1215 30 MAY

MAX  $1.95 \times 10^4$  d/m/m<sup>2</sup>

1330 30 MAY

1330 - 30 MAY 1952

COPIED/DQE  
LAWL RQ

0830 30 MAY

0830 - 30 MAY 52

87

31 may 0730 to 1915

— Ram 2050

COPIED/DOE  
LAVL RC

88  
27



COPIED/DOE  
LAVL RC

MAX.  $1.95 \times 10^9$   
d/m/m<sup>3</sup>

0630 31 MAY 56

COPIED/DOE  
LAVL RC

0630 31 MAY 56

89  
70

17 June 0820 hrs 1230  
2200 hrs 2300

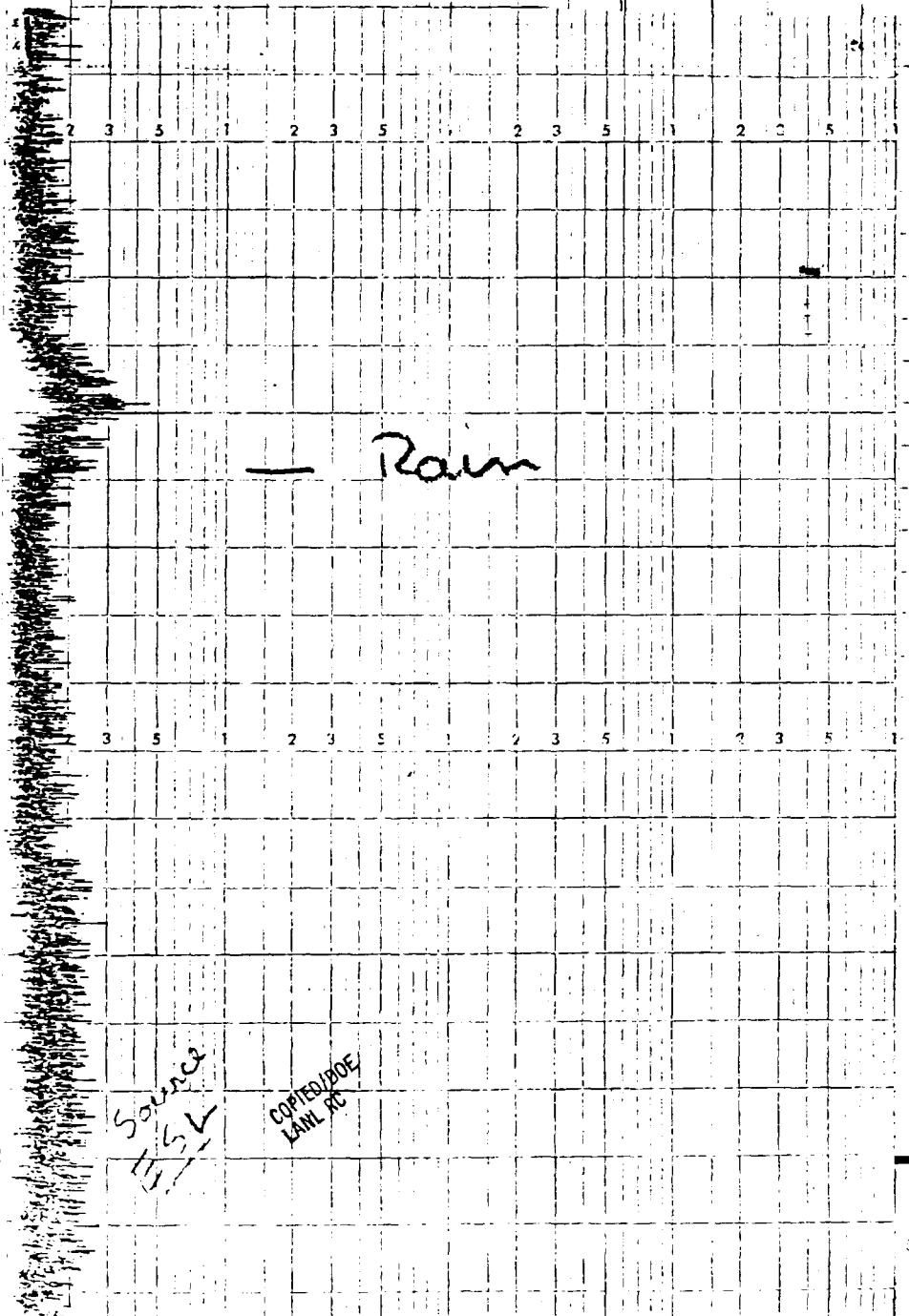

— Rain

Source  
15V  
15V

COPIED/DOE  
KAML RC

10  
31

1230 17 June

12:30 1 June

MAX.  $9.5 \times 10^3$  d/m/m<sup>3</sup>

0820 17 June 56

COLETTOR  
LANL PG

0820 17 June 56

91

8 June 1345, 1530 thru 1630

MAX.  $1.5 \times 10^4$  d/m/a<sup>3</sup>  
Rain

1345 8 June

COPIED/DDE  
LA:11 RC

26 June 1730 thru →  
27 June 0215

MAX.  $3.38 \times 10^5$  4/4  
— nam  
↑ 27 June  
↓ 26 June

← 1730 26 June

10K Scale

← EQUIPMENT FAILURE → 830 AM - 900

1 July 0900

1/4/0

1030 1 July

0900 1 July

Rain

MAX  $1.5 \times 10^4$  d/m/m<sup>3</sup>

COPIED/DONE  
LAWL RG

1k  
900 PM

94  
75

9 July 0745 all day  
decay pattern

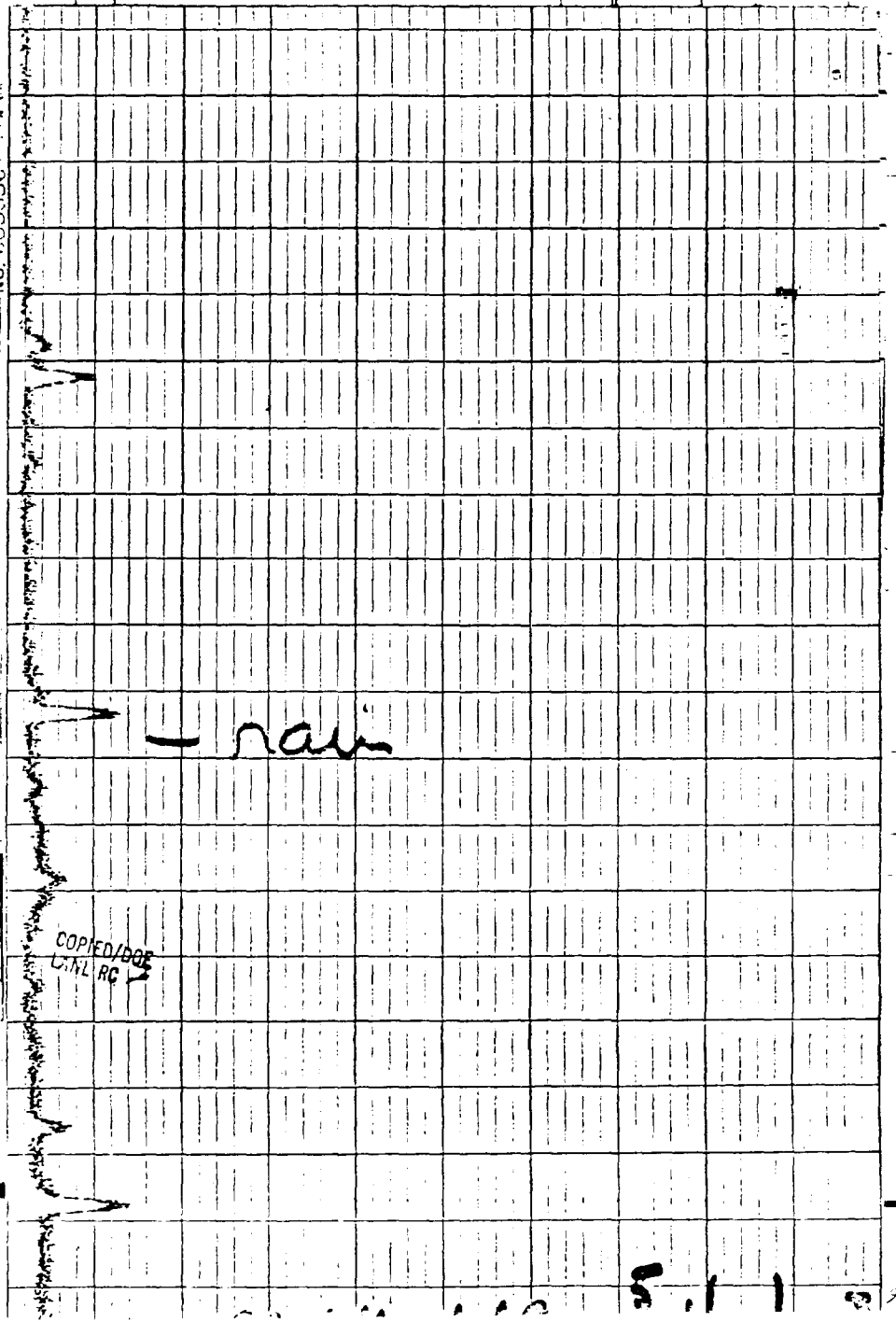

COPIED/DBE  
LTKL RC

9.1 1 9.1 1 9.1 1

COPIED/DOE  
LANL RC

MAX  $1.12 \times 10^5$  d/m/m<sup>3</sup>

0895 - 10K scale

~~10K scale 0895~~

0807 9 July  
4 July

COPIED/DOE  
LANL RC

96





MAX  $3.75 \times 10^5$   $\text{dm}^3/\text{m}^2$

10K Scale

Scale  $\times 10$

1500 11 July

1500 11 July

~~INVALID~~

COPYED  
LISE ED

93

21 July

tape not operating

ED/DGE  
NL/R

Turn on 10K scale 4 ft/sec  
Tape speed 1030 22 July

← Shut OFF 1840

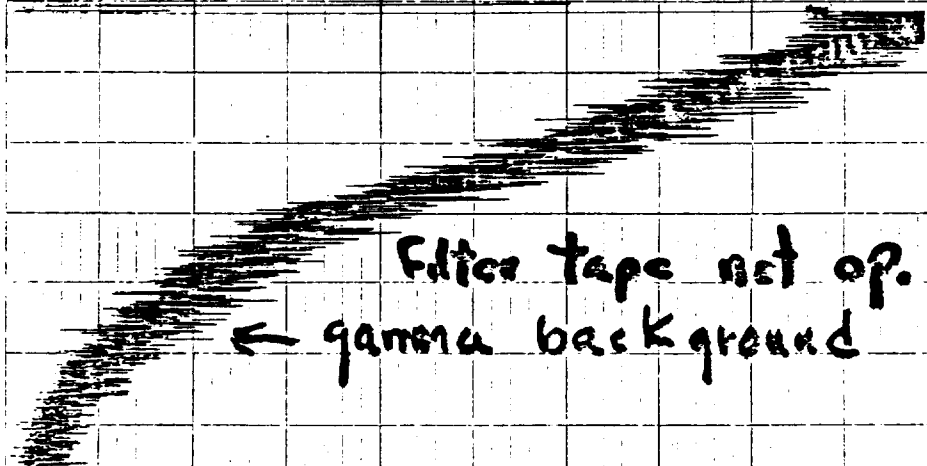

Filter tape not op.  
← gamma background

I 1515

21 July

ED/DGE  
NL/R

D & R Source  
1145 21 July

99  
100



A B C D E F G H I H 5

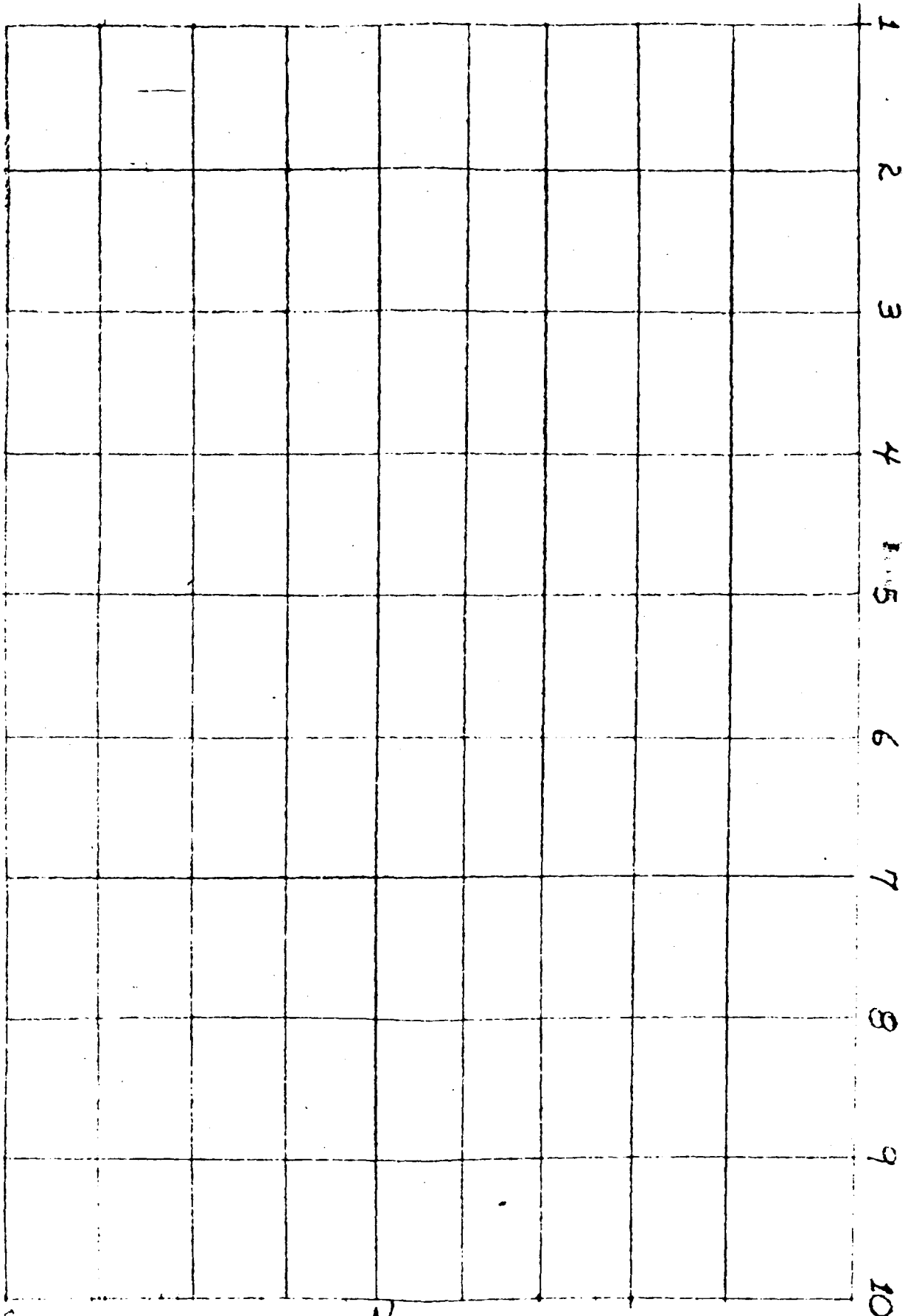

ENCLOSURE  
12 100

101  
102

Rains following heavy fallout 24 July.

Rain #1 2100-23 July -  $5.5 \times 10^7$  d/m<sup>2</sup>

Rain #2 2230-23 July -  $4.04 \times 10^6$  d/m<sup>2</sup>

Rain #3 0720-24 July - 3.2  $\times 10^4$  d/m<sup>2</sup>

2300 sample taken 33% 0720  
1/2 like 14% of appx.

Rain #4 0900-24 July -  $4.36 \times 10^6$  d/m<sup>2</sup>

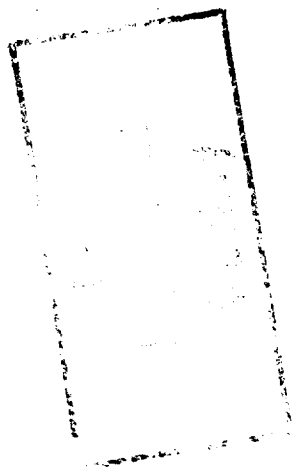

Recommendations

- a. Size
- b. Weight
- c. Filter rewind clutch (redesign)
- d. Overload protection for the main drive transmission.
- e. Hinged doors rather than snap on fasteners.
- f. Scale selector for remote operation.
- g. The original logarithmic amplifier?
- h. Possibility of using short, end window detector tubes - Anton Lab #100IT  
(low background & reduction of pig size)
- i. Future units to record background level (mr./hr.)
- j. Pump oiling requirements every 2 days - not satisfactory for field use.
- k. Laboratory determination of the unit's physical constants and incorporation  
of the data into the instruction manual - detector efficiency, number of  
cubic feet of air whose residue is seen by the detector etc.
- l. More light in the pump compartment.
- m. Brass stack locking nut unsatisfactory due to corrosion.

IV - External plugs incl recorder

O - weather shield & filter screen (bugs)

AIR MONITOR

Recommendations

- ✓ a. Size
- ✓ b. Weight
- ✓ c. Filter rewind clutch (redesign)
- ✓ d. Overload protection for the main drive transmission.
- ✓ e. Hinged doors rather than snap on fasteners.
- ✓ f. Scale selector for remote operation.
- ✓ g. The original logarithmic amplifier?
- ✓ h. Possibility of using short, end window detector tubes - Anton Lab #100IT  
(low background & reduction of pig size)
- ✓ i. Future units to record background level (mr./hr.)
- ✓ j. Pump oiling requirements every 2 days - not satisfactory for field use.
- ✓ k. Laboratory determination of the unit's physical constants and incorporation of the data into the instruction manual - detector efficiency, number of cubic feet of air whose residues is seen by the detector etc.
- ✓ l. More light in the pump compartment.
- ✓ m. Brass stack locking nut unsatisfactory due to corrosion.
- ✓ n. External plugs for remote hook up including the recorder.
- ✓ o. Weather shield and filter screen for intake stack (bug intake often breaks the tape)

*Monitor all 3 prior to  
shipment to E.*



DENSITOMETER

Recommendations

- (1) Light port in front
- (2) Larger zero knob
- (3) Badge holder that remains attached to unit.
- (4) #3 - Possibility of a feed through holder for continuous or automatic processing.
- (5) Range selection - (0 - 1 full scale)
- (6) Black on white read out register.
- (7) Proper ventilation for projector lamp. (180°F-145°F)
- (8) Possible use of concentrated arc lamp to accomplish #9.
- (9) Reduction of hunting and over shoot.
- (10) Parts mounted on power switches subject to damage in shipment.
- (11) Mirror alignment difficult.
- (12) Set screws in mechanical section often come loose and fall out.
- (13) Zero adjust drive alignment subject to shipping troubles.
- (14) Possibility of dynode by-pass capacitors as noise reduction measure.
- (15) Drive speed & stability characteristics drift considerably on a weekly basis requiring frequent adjustment.
- (16) Present badge holders warp and often break directly behind the badge slot.

INTEGRON

These instruments were used little due to several factors.

(1) It was difficult due to time restrictions to advertise and acquaint personnel with their operation and usefulness.

(2) Personnel generally dislike hauling around an extra piece of equipment, especially in hot areas where speed is necessary. The pocket dosimeters often provide enough information for the needs of the party.

Upon arrival only four units were operable. The relatively heavy warning system batteries are not adequately supported causing the whole chassis structure to bend. Chamber plug damage during shipping resulted. Moisture sensitivity was noticed; it was however not of a really serious nature. Calibration was done every month with 20 - 25% corrections necessary.

The future usefulness of the integron will depend upon creating a need for such an instrument amongst project leaders etc.

THYAC (ALPHA CONVERTED)

The converted thyac with circuit changes to increase the trigger period and integration constant seems to be a very good field unit. It has not shown itself to be moisture or temperature sensitive. The probe must be handled gently and a rather high photo multiplier mortality rate has been noted. A guard ring should be added as further protection of the very thin mylar window. The probe may be used for short periods of time in any desired position due to the high viscosity of the silicone coupling compound and shape of its cavity in the light pipe.

The unit is capable of calibration to provide  $4\pi$  readings with reasonable accuracy. Due to our lack of range in alpha sources they have only been checked at 400, 1800, 8800 and 3320 d/m.

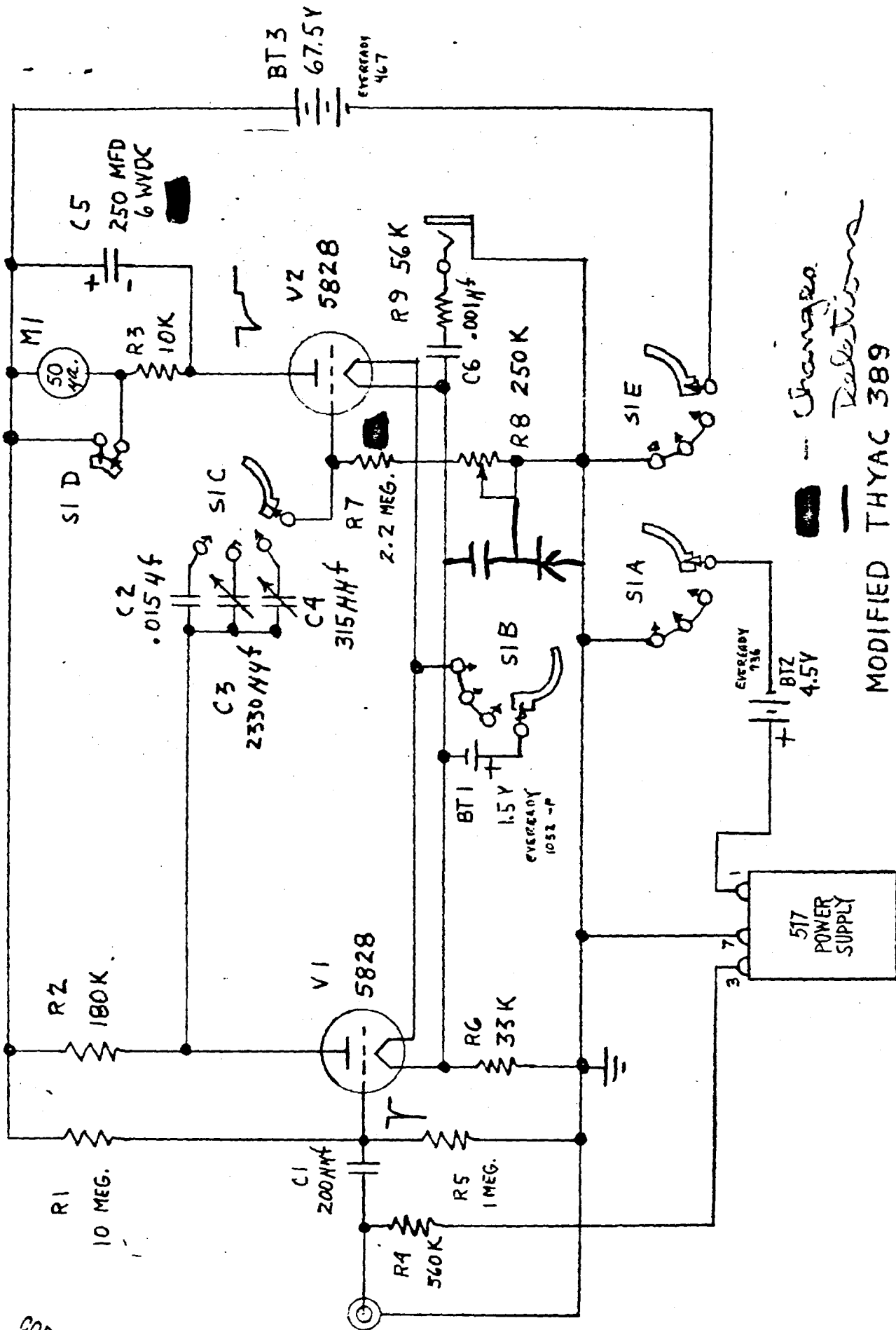

--- Changero.  
 --- Relativona  
**MODIFIED THYAC 389**

FOR USE WITH ALPHA SCINTILLATION PROBE.

COPIED/DOE  
 LANL RG

108  
 108

RESISTANCE CALIBRATION OF AN-PDR-39's

The Tl-B or PDR-39 instruments rely on the accuracy of their hi-meg or chamber load resistances for scale decoding. A single calibration control (meter series resistance) performs calibration of all scales at once.

It was felt that some method of assuring hi-meg accuracy should be used to check all instruments before they met field use. It was also felt that the Victoreen deposited carbon hi-meg resistances might be highly voltage sensitive and should be checked under circumstances approximating their actual operating potentials. Commercial hi-meg ohm meters often use potentials up to 1000 volts making them unsuitable for this application. An Applied Physics Corp. vibrating reed electrometer was used to measure the potential across a 100 megohm standard resistance (calibrated to value  $\pm .3\%$ ) in series with the unknown hi-meg (in place in the instrument). All resistors varying more than 5% were replaced. No attempt to calibrate the 0 to 5 mr. range was made.

The standard Bendix bridge and sub miniature tube tester<sup>supplied</sup> by the Army for use with the instruments uses a potential of 16 volts across the unknown resistance. It is felt that the Bendix unit serves the purpose well - better perhaps than the electrometer technique which is of a laboratory nature.

For most accurate results each instrument should be calibrated on the scale representing the mean deviation (since each scale varies  $\pm$  a few percent). Time was not available for this purpose. Each Tl-B carries within it a card giving the deviations for future use.

The PDR-39 schematic places the 5 mr and 50 mr scales in parallel. This results in a 10% deviation (low) it was noticed however that the 10% deviation was not always forthcoming when the instrument was radiation calibrated. Further study should reveal use-ful characteristic information.

The deviation percentage given on the cards in the instruments pertains to

error when radiation is read.

COPIED/DOE  
LANL RC

109

$d/m/r$   
 $\times 1000$

$d/m/r$   
 $\times 100$

35A-51L KRUEFF & Co.  
Semi-Logarithmic, 2 Cycle, 2000 Lines  
MADE IN U.S.A.

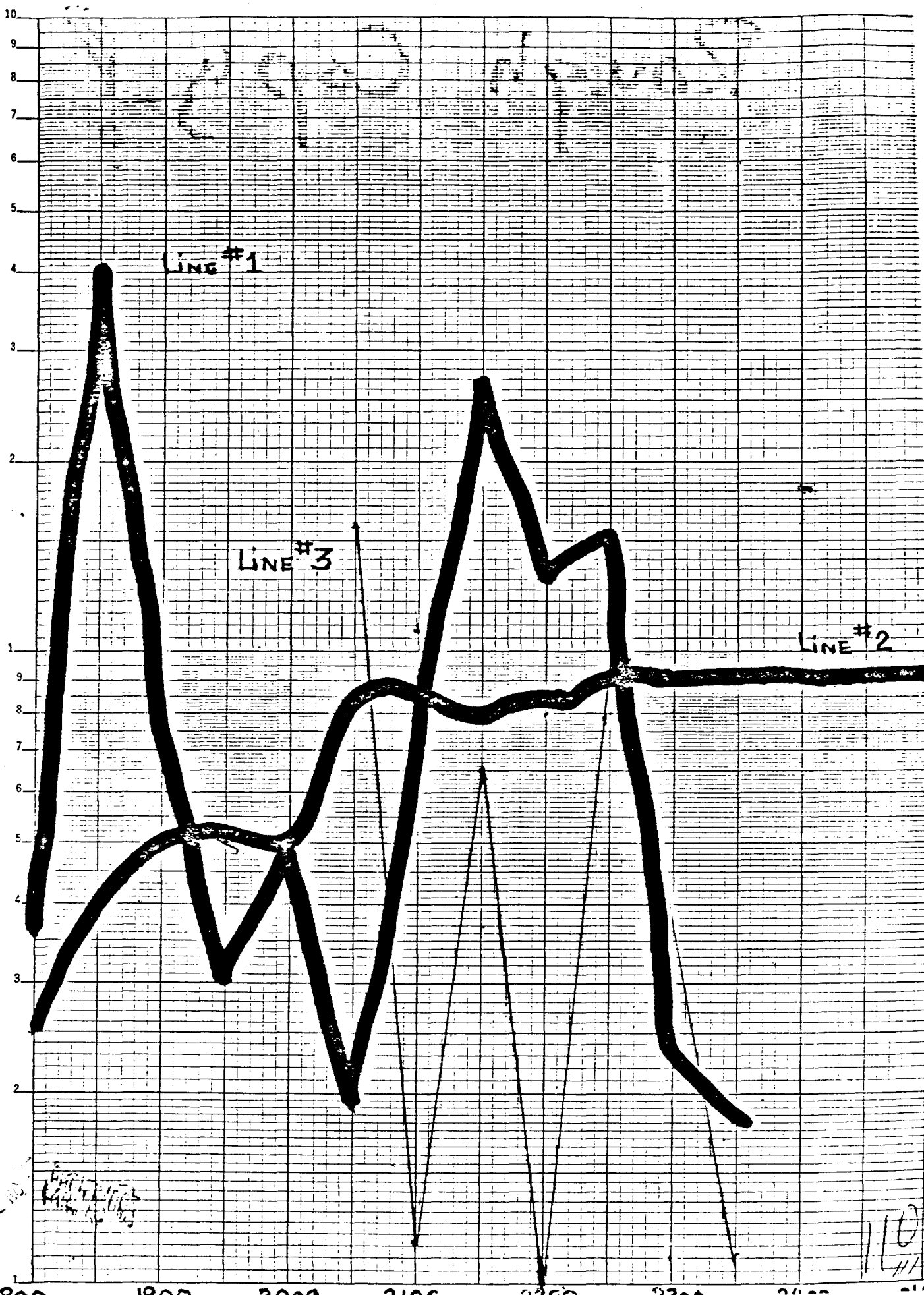

1800 1900 2000 2100 2200 2300 2400

110  
#1

Line # 1 - airborne d/m/l ground level  
 Line # 2 - ground m/hr  
 Line # 3 - airborne d/m/l 8 feet above # 1

Background

July 21	0600	2 m
22	"	90+
23	"	60
24	"	35
25	"	19
26	"	10

COPIED/D/E  
 LANL RE

1200	1800	2400	0600	1200	1800
21 July		22 July			

The proper folding  
of this chart presents  
a challenge -

if duties press  
and time flies then  
perhaps the presently  
infuriating moments  
spent unraveling the  
simple logic of the  
fold are well spent.



COPIED/DOE  
LANL RC

112  
113



COPIED/DOE  
LANL RC

No. 339-14 Millimeters, 3 mm lines centered, cm lines heavy.

NEUTRON LABORATORY

CONTINUOUS AIR MONITOR

SERIAL NO 103

SCALE 100K

21 MAY 1956

R. ZIMMERS

Inst. Reading C.P.M. X 10<sup>4</sup>

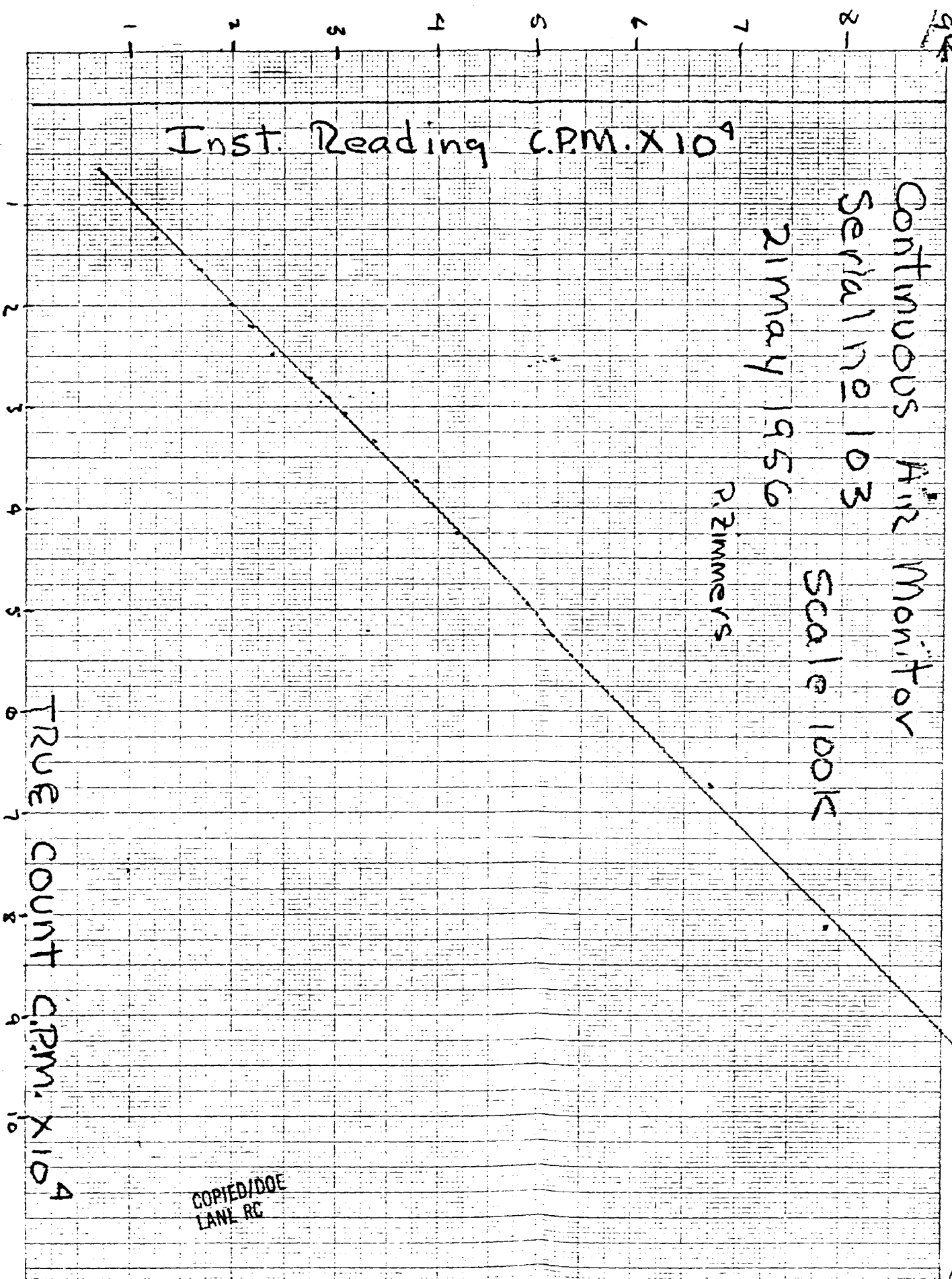

TRUE COUNT C.P.M. X 10<sup>4</sup>

COPIED/DOE  
LANL RC

113  
114

114

CONTINUOUS AIR MONITOR  
Serial No 103  
21 May 1956  
Scale 10K  
P. Zimmers

Inst. Reading C.P.M.  $\times 10^3$

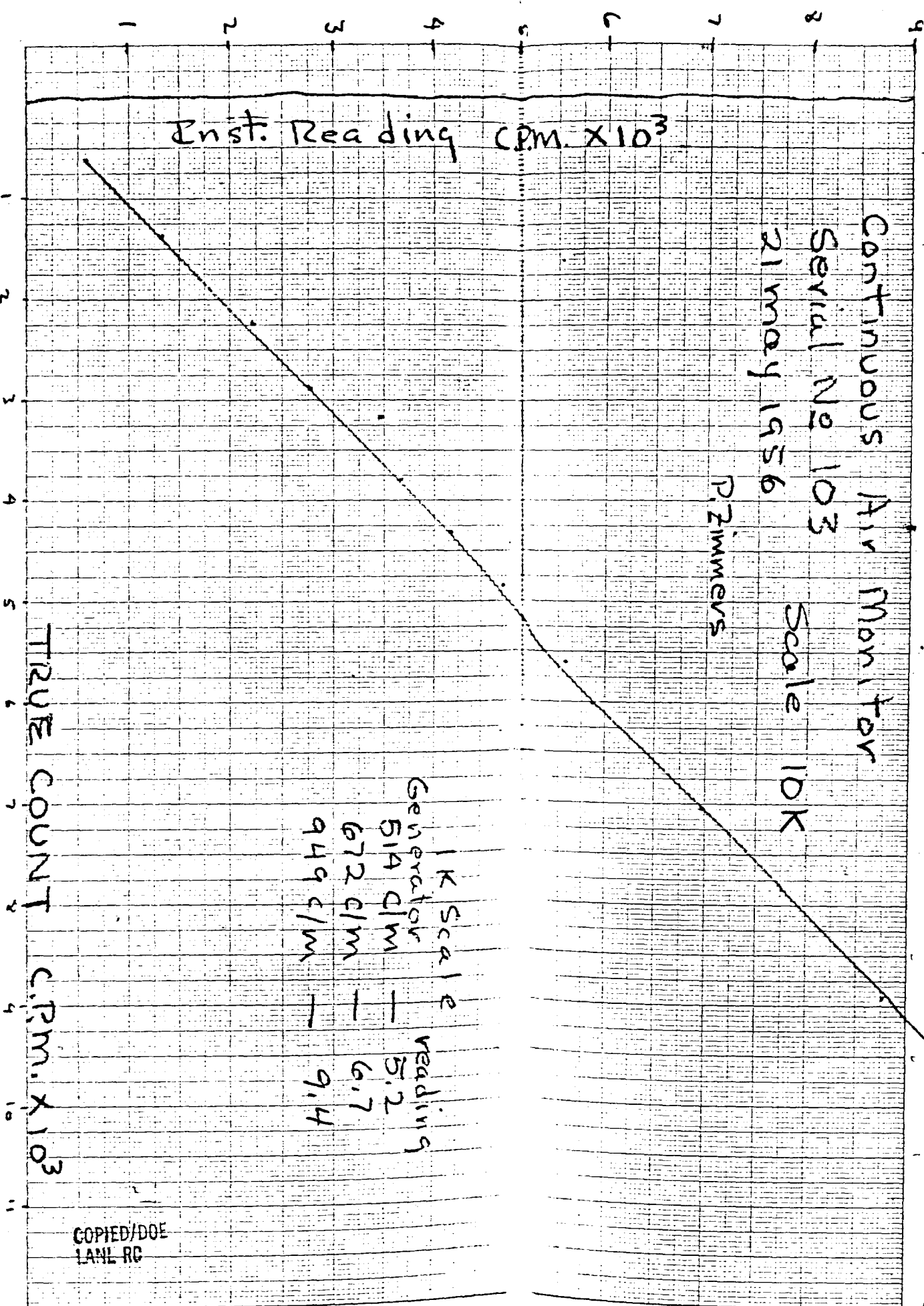

1K Scale  
Generator  
514 c/m — 5.2  
672 c/m — 6.7  
949 c/m — 9.4  
Reading

TRUE COUNT C.P.M.  $\times 10^3$

COPIED/DOE  
LANL RC

TO: MR. ZIMMERS - RADSAPR ELMER

MAY 26, 1956			MAY 29, 1956			JUN 1, 1956		
TYPE	BEGAN	ENDED	TYPE	BEGAN	ENDED	TYPE	BEGAN	ENDED
RW-	0543	0549	RW-	0159	0201	RW--	0232	0234
RW-	0627	0634	RW-	0201	0213	RW--	0633	0638
RW-	1307	1309	RW-	0213	0217	RW--	0811	0817
RW	1309	1325	RW	0217	0221	RW-	1002	1006
RW-	1325	1328	RW-	0221	0232	RW	1248	1257
RW--	1328	1339	RW	0232	0238	RW--	1257	1312
R--	1349	1358	RW--	0238	0246	RW-	1710	1724
RW-	2354	2356	RW-	0320	0326	RW--	1924	1931
MAY 27, 1956			RW-	0337	0340	RW-	1936	1940
TYPE	BEGAN	ENDED	RW-	0341	0349	RW--	1940	1945
RW-	0219	0223	RW-	0349	0354	RW--	1958	2001
MAY 28, 1956			RW--	0354	0402	RW-	2001	2008
TYPE	BEGAN	ENDED	RW--	0431	0437	RW-	2240	2245
RW--	0320	0123	MAY 31, 1956			R--	2245	2306
RW-	0509	0514	TYPE	BEGAN	ENDED			
RW--	1730	1734	RW--	2044	2103			
RW--	1858	1903	RW--	2140	2154			
			RW--	2205	2214			
			RW--	2303	2310			
			RW--	2329	2342			

COPIED/DOE  
LANL RG

JUN 2, 1956			JUN 3, 1956			JUN 7, 1956		
TYPE	BEGAN	ENDED	TYPE	BEGAN	ENDED	TYPE	BEGAN	ENDED
RW--	0434	0457	R--	0003	0109	RW--	1849	1909
RW-	0457	0505	R--	0141	0314	RW-	1944	1949
RW--	0505	0513	R--	0647	0657	RW	1949	1953
RW-	0513	0524	R-	0657	0706	RW-	1953	2003
RW--	0524	0555	R--	0706	0720	RW	CONTINUED	0014
RW-	0555	0638	R--	0730	0837	RW-	0014	0019
RW--	0638	0735	JUN 4, 1956			RW--	0019	0029
RW--	0740	0745				TYPE	BEGAN	ENDED
RW-	1113	1226	RW--	2350	2355	RW	0034	0039
RW--	1226	1228	JUN 5, 1956			RW	0039	0049
R	1228	1233				TYPE	BEGAN	ENDED
R+	1234	1316	R--	0528	0545	RW-	0114	0124
R	1316	1523	R--	0545	0609	RW--	0124	0139
R--	1523	1545	R-	1341	1346	RW--	0213	0217
R-	1545	1557	R--	1346	1357	RW-	0254	0302
R	1608	<del>2104</del> 2704	RW--	1426	1444	RW--	0529	0535
R-	2104	2244	JUN 6, 1956			RW--	0556	0608
R--	2244	2334				TYPE	BEGAN	ENDED
			RW--	2249	2304	RW--	1757	1804
			RW--	2354	2356	RW--	1824	1827
			RW	2356	CONTINUED	RW-	1827	1830
						RW	1830	1835
						RW-	1835	1842

COPIED/DOE  
LANL RG

116  
117

COPIED/DOE  
LANL RC

JUN 8, 1956			JUN 25, 1956			JUN 29, 1956		
TYPE	BEGAN	ENDED	TYPE	BEGAN	ENDED	TYPE	BEGAN	ENDED
RW-	0721	0741	RW--	0445	0504	RW-	0250	0257
RW+	0741	0744	RW--	1513	1519	RW	0257	0301
RW-	0744	0748	RW-	1519	1522	RW--	0301	0312
RW-	1534	1656	JUN 26, 1956			RW--	0412	0419
RW--	2010	2012	TYPE	BEGAN	ENDED	RW--	1807	1845
RW-	2012	2014	RW-	1156	1159	RW--	2328	2332
RW	2014	2016	JUN 27, 1956			JUN 30, 1956		
RW+	2016	2024	TYPE	BEGAN	ENDED	TYPE	BEGAN	ENDED
RW	2024	2026	RW--	0147	0201	RW--	0145	0155
RW-	2026	2030	RW--	0259	0310	RW-	0155	0157
RW--	2030	2119	RW	0310	0314	RW--	0157	0206
JUN 9, 1956			RW-	0314	0321	RW--	0624	0634
TYPE	BEGAN	ENDED	RW--	0321	0331	RW-	0641	0648
RW--	1925	1928	RW--	0729	0736	RW-	0648	0656
JUN 10, 1956			RW-	0736	0744	RW	0822	0834
TYPE	BEGAN	ENDED	28 JUN, 1956			RW--	1334	1352
RW--	1947	1949	TYPE	BEGAN	ENDED	RW--	1944	1947
RW-	1949	1952	RW--	0112	0118			
RW--	1952	2004	RW-	0118	0125			
			RW--	0125	0151			
			RW-	1013	1015			
RW--	2129	2134	RW-	1057	1103			
				1909	1911			

117

Jul 1, 1956			Jul 2, 1956			Jul 4, 1956		
TYPE	BEGAN	ENDED	TYPE	BEGAN	ENDED	TYPE	BEGAN	ENDED
RW	0330	0348	RW--	1357	1400	RW--	0359	0404
RW--	0348	0410	RW--	1429	1433	RW--	1529	1539
RW-	0410	0419	RW-	1433	1441	R--	2001	2019
RW--	0419	0431	RW--	1829	1839	Jul 5, 1956		
RW--	0610	0629	RW--	1843	1907			
RW--	0629	0632	RW--	1949	1951	RW--	0539	0632
RW-	0632	0639	RW	1951	1953	RW-	0656	0706
RW-	0639	0706	RW-	1953	1956	RW-	1149	1200
RW--	0706	0826	RW	1956	2003	RW--	1303	1318
RW-	0936	0949	RW-	2003	2016	RW--	1510	1611
RW--	0949	1012	RW--	2026	2104	RW-	1756	1757
RW-	1322	1325	RW--	2144	2200	RW+	1757	1804
RW	1325	1332	RW-	2332	2339	RW	1804	1810
RW--	1744	1804	RW+	2339	2341	RW-	1810	1814
RW--	1840	1911	RW	2341	CONTINUED	R--	1902	1949
RW-	1911	1913	Jul 3, 1956					
RW	1914	1918	TYPE	BEGAN	ENDED			
RW--	1918	1926	RW	CONTINUED	0227			
RW	1926	1934	RW--	0329	0511			
RW-	1934	1937	R-	0727	1214			
RW--	1937	1944	RW--	1445	1500			

COPIED/DOE  
LANL RC

118  
119

JUL 20, 1956

JUL 23, 1956

JUL 20, 1956			JUL 23, 1956		
TYPE	BEGAN	ENDED	TYPE	BEGAN	ENDED
RW--	1207	1211	R--	0005	0025
RW-	1215	1219	R--	0126	0305
RW+	1219	1239	R--	0356	0408
RW-	1239	1249	R	0408	0428
RW--	1307	1312	R-	0428	0431
RW-	1442	1514	R--	0431	0554
JUL 21, 1956			R--	0600	0650
TYPE	BEGAN	ENDED	R	0650	0653
RW--	2158	2204	R-	0653	0657
RW--	2254	2302	R	0657	0708
JUL 22, 1956			R--	0708	0712
TYPE	BEGAN	ENDED	RW--	1146	1156
RW--	0338	0348	RW--	1204	1310
RW--	0707	0723	RW-	2227	2346
RW--	0739	0749			
RW-	0900	1009			
RW	1200	1213			
RW--	1414	1418			
RW-	1716	1740			
RW--	1947	2003			
RW--	2014	2109			

COPIED/DOE

COPIED/DOE  
LAWL RC

119 100

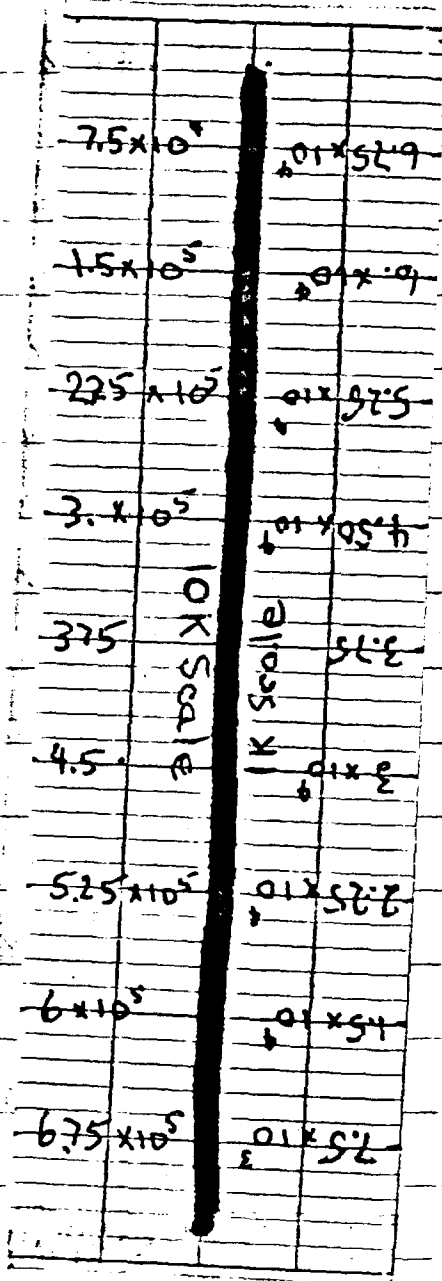

COPIED/EN  
LANL RC

120



