

Chang

MARSHALL ISLANDS FILE TRACKING DOCUMENT

Record Number: 29

File Name (TITLE): Electromagnetic Radiation  
Calibration, Ap. Castle

*A* Document Number (ID): WT-930 (EX)

DATE: 6/1958

Previous Location (FROM): CIC

AUTHOR: M. H. Olson, USAF

Additional Information: \_\_\_\_\_

OrMIbox: 2

CyMIbox: 2

WT-930 (EX)  
EXTRACTED VERSION

OPERATION CASTLE

PROJECT 7.1

1051381

ELECTROMAGNETIC RADIATION CALIBRATION

PACIFIC PROVING GROUNDS

March - May 1954

Headquarters Field Command  
Armed Forces Special Weapons Project  
Sandia Base, Albuquerque, New Mexico

June 13, 1958

NOTICE

This is an extract of WT-930, which  
remains classified SECRET/RESTRICTED  
DATA as of this date.

Extract version prepared for:

Director

Defense Nuclear Agency

Washington, D. C. 20305

31 August 1984

Approved for public release;  
distribution unlimited.

REPORT DOCUMENTATION PAGE		READ INSTRUCTIONS BEFORE COMPLETING FORM
1. REPORT NUMBER WT-930 (EX)	2. GOVT ACCESSION NO.	3. RECIPIENT'S CATALOG NUMBER
4. TITLE (and Subtitle) OPERATION CASTLE, PROJECT 7.1, ELECTROMAGNETIC RADIATION CALIBRATION		5. TYPE OF REPORT & PERIOD COVERED
		6. PERFORMING ORG. REPORT NUMBER WT-930 (EX)
7. AUTHOR(s) M. H. Olseon		8. CONTRACT OR GRANT NUMBER(s)
9. PERFORMING ORGANIZATION NAME AND ADDRESS Headquarters, USAF Office for Atomic Energy, DCS/O - AFOAT-1 Washington, D. C.		10. PROGRAM ELEMENT, PROJECT, TASK AREA & WORK UNIT NUMBERS
11. CONTROLLING OFFICE NAME AND ADDRESS Headquarters Field Command Armed Forces Special Weapons Project Sandia Base, Albuquerque, New Mexico		12. REPORT DATE June 13, 1958
		13. NUMBER OF PAGES
14. MONITORING AGENCY NAME & ADDRESS (if different from Controlling Office)		15. SECURITY CLASS. (of this report)  UNCLASSIFIED
		15a. DECLASSIFICATION/DOWNGRADING SCHEDULE
16. DISTRIBUTION STATEMENT (of this Report) Approved for public release; unlimited distribution.		
17. DISTRIBUTION STATEMENT (of the abstract entered in Block 20, if different from Report)		
18. SUPPLEMENTARY NOTES This report has had the classified information removed and has been republished in unclassified form for public release. This work was performed by Kaman Tempo under contract DNA001-83-C-0286 with the close cooperation of the Classification Management Division of the Defense Nuclear Agency.		
19. KEY WORDS (Continue on reverse side if necessary and identify by block number) Operation CASTLE Electromagnetic Radiation Calibration Instrumentation		
20. ABSTRACT (Continue on reverse side if necessary and identify by block number) A total of 17 stations, one close-in (320 km from Bikini and 23 km from Eniwetok) and the balance at distances, were operated for the AFOAT-1 electromagnetic experimental effort. Seventy-four sets of data were obtained from a possible total of 102. Of the remaining 28 sets, no data were obtained because equipment was not in operation, records were not readable, the alert notifications were not received, signals were not discernible, or equipment malfunctioned.		

## FOREWORD

This report has had classified material removed in order to make the information available on an unclassified, open publication basis, to any interested parties. This effort to declassify this report has been accomplished specifically to support the Department of Defense Nuclear Test Personnel Review (NTPR) Program. The objective is to facilitate studies of the low levels of radiation received by some individuals during the atmospheric nuclear test program by making as much information as possible available to all interested parties.

The material which has been deleted is all currently classified as Restricted Data or Formerly Restricted Data under the provision of the Atomic Energy Act of 1954, (as amended) or is National Security Information.

This report has been reproduced directly from available copies of the original material. The locations from which material has been deleted is generally obvious by the spacings and "holes" in the text. Thus the context of the material deleted is identified to assist the reader in the determination of whether the deleted information is germane to his study.

It is the belief of the individuals who have participated in preparing this report by deleting the classified material and of the Defense Nuclear Agency that the report accurately portrays the contents of the original and that the deleted material is of little or no significance to studies into the amounts or types of radiation received by any individuals during the atmospheric nuclear test program.

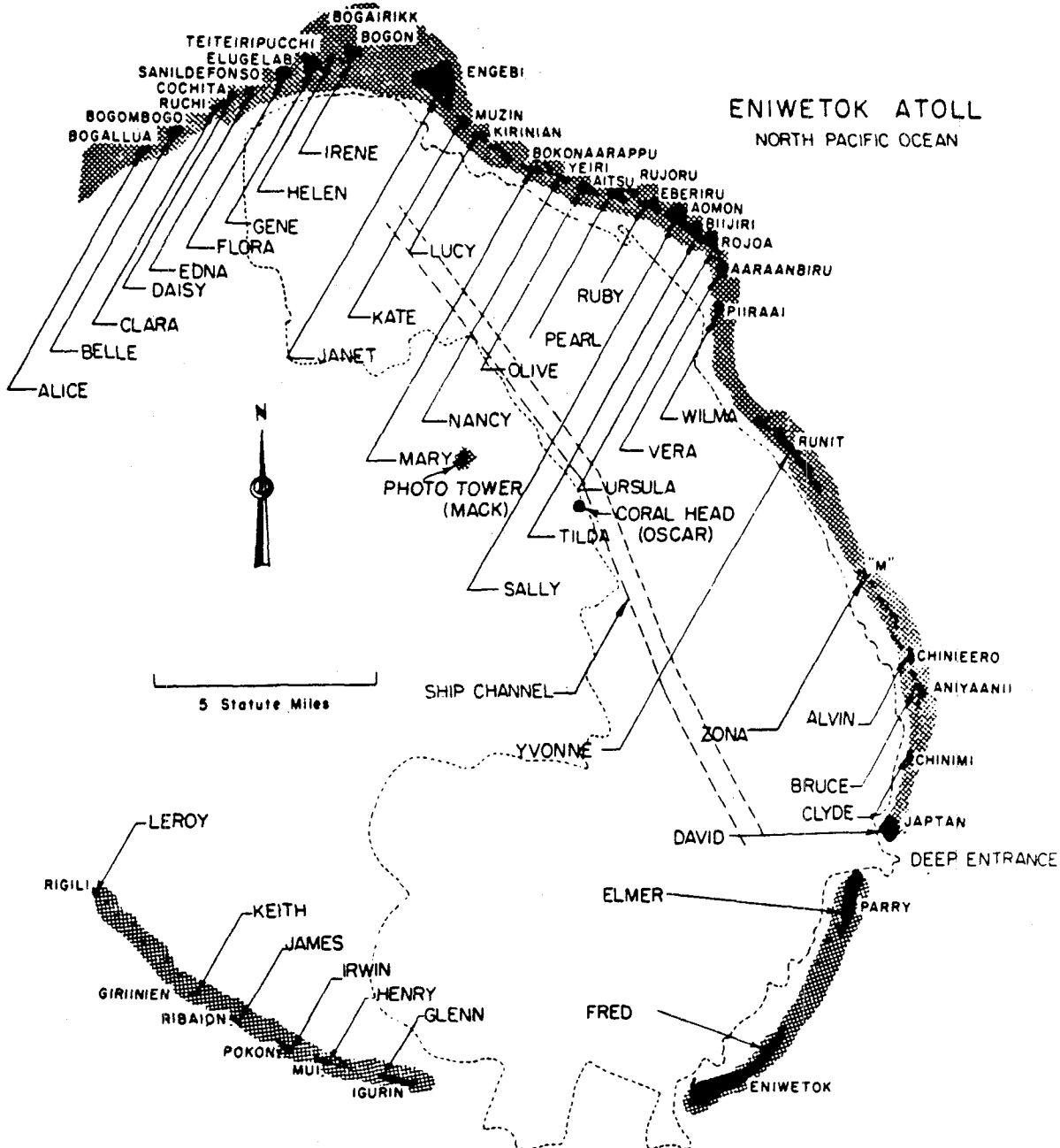

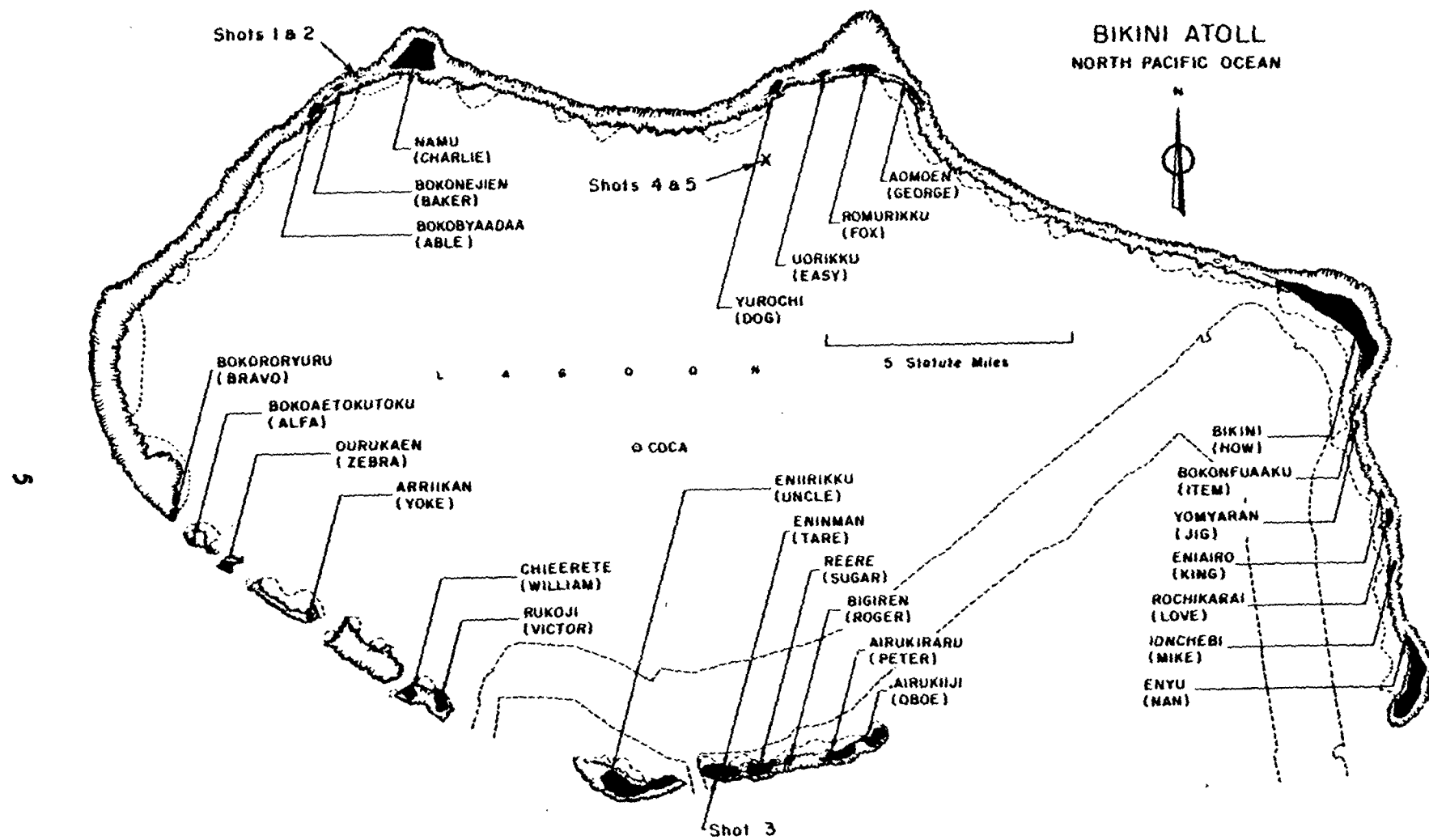

GENERAL SHOT INFORMATION

Shot	DATE	CODE NAME (Unclassified)	TIME*	LOCATION	TYPE	COORDINATES
Shot 1	1 March	Bravo	06:40	Bikini, West of Charlie (Nomu) on Reef	Land	N 170,617.17 E 76,163.98
Shot 2	27 March	Romeo	06:25	Bikini, Shot 1 Crater	Barge	N 170,635.05 E 75,950.46
Shot 3	7 April	Koon	06:15	Bikini, Tare (Eninman)	Land	N 100,154.50 E 109,799.00
Shot 4	26 April	Union	06:05	Bikini, on Barge at Intersection of Arcs with Radii of 6900' from Dog (Yurochi) and 3 Statute Miles from Fox (Aomoen).	Barge	N 161,698.83 E 116,800.27
Shot 5	5 May	Yankee	06:05	Eniwetok, IVY Mike Crater, Flora (Elugelob)	Barge	N 161,424.43 E 116,688.15
Shot 6	14 May	Nectar	06:15		Barge	N 147,750.00 E 67,790.00

\* APPROXIMATE

## ABSTRACT

A total of 17 stations, one close-in (320 km from Bikini and 23 km from Eniwetok) and the balance at distances, were operated for the AFOAT-1 electromagnetic experimental effort. Seventy-four sets of data were obtained from a possible total of 102. Of the remaining 28 sets, no data were obtained because equipment was not in operation, records were not readable, the alert notifications were not received, signals were not discernible, or equipment malfunctioned.

Broad-band (close-in, up to 40 Mc; at distances, about 100 kc) and narrow-band (about 200 cycles) measurements were made of the vertical field component. Close-in waveforms and field strengths were recorded for all shots except the first. Signals were received and waveforms, field strengths and azimuths were recorded at distances exceeding 12,000 km for both a north-south and an east-west path.

Spectrum analyses of the frequency content of the close-in waveforms confirm the theoretical conclusion that the predominant frequency becomes lower as the yield increases. For a nuclear weapon in the 10-Mt range, the predominant frequency is about 8 to 10 kc, while in the 100-kt range it is about 18 to 20 kc.

Analyses of broad-band pulses received at distances show that the higher frequencies are attenuated relatively more and, when received at several thousand kilometers, the close-in differences largely disappear. An approximation of yield may be obtained at distances by measurement of peak field strengths.

Where equipment capabilities permitted, times of detonation—after allowing for travel time of the nuclear detonation signals and standard time signals—were measured to within 2 msec, with one exception.

Transmitting stations in the very low frequency band were monitored at selected intervals. Generally, a north-south path crossing the auroral zone shows greater attenuation than an east-west path of equivalent distance.

## FOREWORD

This report is one of the reports presenting the results of the 34 projects participating in the Military Effects Tests Program of Operation Castle, which included six test detonations. For readers interested in other pertinent test information, reference is made to WT-934, "Summary Report of the Commander, Task Unit 13, Programs 1-9," Military Effects Program. This summary report includes the following information of possible general interest: (1) An overall description of each detonation, including yield, height of burst, ground zero location, time of detonation, ambient atmospheric conditions at detonation, etc., for the six shots; (2) Discussion of all project results; (3) A summary of each project, including objectives and results; (4) A complete listing of all reports covering the Military Effects Tests Program.

## PREFACE

The experimental and analytical work which this report summarizes was performed by the staffs of the National Bureau of Standards and the Defense Research Laboratory of the University of Texas. The Sferics Operations staff of the Air Weather Service operated standard very low frequency direction-finding equipment at detonation times as requested by AFOAT-1. AFOAT-1 appreciates the efforts and close cooperation that have characterized the people of the above groups working on the problem of Long Range Detection ] and especially

Dr. Otto J. Baltzer, Defense Research Laboratory

A. Glenn Jean, Jr., National Bureau of Standards

A. G. McNish, National Bureau of Standards

Capt. Mack Siler, Air Weather Service

Lt. Col. Paul Wignall and his staff of the Special Projects Branch of AFOAT-1 handled the operational matters in a helpful and expeditious manner. Members of the three AFOAT-1 electromagnetic stations furnished data at a difficult time when the stations were being put into operation on a 24-hour basis. Mrs. Margaret Beach furnished valuable assistance in the preparation of the report.

# CONTENTS

ABSTRACT .....	7
FOREWORD .....	8
PREFACE .....	8
ELECTROMAGNETIC RADIATION CALIBRATION .....	11
Objectives .....	11
Background .....	11
INSTRUMENTATION .....	12
World-wide Timing .....	12
Local Timing .....	12
National Bureau of Standards Close-in Station .....	15
Distant Stations .....	15
OPERATIONS .....	16
Equipment .....	16
Station Locations .....	16
Special Measurements .....	16
Alert Notifications .....	16
Low-frequency Interference .....	18
RESULTS AND OBSERVATIONS .....	18
Teller Light .....	18
Field Strenghts .....	18
Records .....	22
Fourier Analyses .....	25
Yield and Predominant Frequency .....	33
Narrow-Band Records .....	33
Peripheral Lighting Flashes .....	33
Low-Frequency Transmitters .....	33
CONCLUSIONS AND RECOMMENDATIONS .....	39
REFERENCES .....	40
TABLES	
1 Summary of Castle Results .....	19
FIGURES	
1 Timing traces recorded by NBS at Parry Island, Eniwetok Atoll.	13
2 Typical NBS narrow-band field strenght traces, with a timing trace recorded on a multi-beam oscillosope at a distant location .....	13

3	Block diagram showing the NBS close-in waveform instrumentation .....	14
4	Pretinent information on Castle electromagnetic stations .....	17
5	Plot of selected Castle data showing the relationship between peak field strenght and yield on an east-west path.....	23
6	Plot of selected Castle data showing the relationship between peak field strenght and yield on a north-south path .....	24
7	Selected records from Shot 1 detonated on 28 February 1954 at Bikini .....	26
8	Selected records from Shot 2 detonated on 26 March 1954 at Bikini .....	27
9	Selected records from Shot 3 detonated on 6 April 1954 at Bikini .....	28
10	Selected records from Shot 4 detonated on 24 April 1954 at Bikini .....	29
11	Selected records from Shot 5 detonated on 4 May 1954 at Bikini .....	30
12	Selected records from Shot 6 detonated on 13 May 1954 at Eniwetok .....	31
13	Broad-band spectral curves for shot 2 as recived at NBS stations .....	32
14	Spectral intensity, as a function of frequency, for Shot 2 as recived at selected NBS stations .....	34
15	Spectral intensity, as a function of frequency, for Shot 3 as recived at selected NBS stations .....	34
16	Plot of selected Upshot-Knothole and Castle close-in waveforms showing the relationship between yield and predominant frequency .....	35
17	Plot of the field strength of NSS as measured by DRL at Kirknewton, Scotland .....	36
18	Plot of the field strength of NSS as measured by DRL at Thule, Greenland .....	37
19	Plot of the field strength of NPM as measured by DRL at Thule, Greenland .....	37
20	Plot of the field strength of NPM as measured by DRL at Austin, Texas .....	38
21	Plot of the field strength of NSS as measured by DRL at Austin, Texas .....	38

# ELECTROMAGNETIC RADIATION CALIBRATION

## OBJECTIVES

In order to gain maximum information on nuclear detonations as determined from the electromagnetic pulse received at distances, there are two fundamental problems; first, the discrimination of nuclear-weapon pulses from natural atmospheric and second, the determination of the maximum information on the source itself and external conditions at detonation time, from the characteristics of the selected pulse. The 7.1 Castle project offered an opportunity to monitor detonations of nuclear devices of known composition and characteristics. More specific objectives can be summarized as follows:

1. Determination of pulse character before changes due to propagation become apparent.
2. Determination of pulse character as a function of external parameters such as distance, time of day, and ionospheric conditions.
3. Measurement of field strength.
4. Explanation of the causes of the electromagnetic phenomena observed.
5. Relation of pulse occurrence to sequence of events during the detonation.
6. Relation between nuclear-weapon characteristics and pulse characteristics, both close-in, and, insofar as possible, at distances.
7. Experimentation with prototype surveillance equipment.
8. Measurement of azimuthal errors in direction-finding equipment.
9. Determination of times of pulse reception to within 1 msec in world time.

## BACKGROUND

AFOAT-1 has supported experimental measurements of the pulse emitted at the time of a nuclear detonation during each series of atomic tests beginning with Buster-Jangle (Autumn, 1951). As a result of these experiments (References 1,2,3), the following can be stated with some assurance:

1. There is an electromagnetic pulse less than 100  $\mu$ sec long emitted at the time of a nuclear detonation.
2. At a distance of 20 km from the generating source, the field strength may be a few hundred volts per meter.
3. There is a general relationship between kiloton yield and the vertical component of the electromagnetic field.
4. The emitted frequency spectrum extends from about 2 kc or below up to a few megacycles, but the main components are in the region of about 6 to 50 kc.

5. There is an approximate inverse relationship between yield and predominant frequency.

6. Pulses received close-in (i.e. approximately 20 km) exhibit very short rise times (less than a microsecond) in a negative direction (i.e. the electric field vector is downward).

7. The pulse is predominantly vertically polarized.

8. Close-in reception indicates that certain nuclear-weapon characteristics can be determined from pulse fine structure.

9. Even low-yield nuclear detonations can produce a pulse receivable at distances in excess of 1,000 km.

10. The ground wave is generally not detectable beyond about 1,500 km from the source because the ionospheric sky wave reflections predominate.

11. A fix of the source of the pulse can be obtained with direction-finding equipment; observed azimuthal errors to date using equipment tuned to 10 kc have been between 0 and 9 degrees; most errors have been less than 3 degrees.

12. At distances, the pulse is extended to approximately ten times its close-in length. This is the result of multiple arrivals by various paths, each characterized by one or more ionospheric reflection.

13. Close-in fine structure disappears during sky wave propagation to distances.

## INSTRUMENTATION

All stations, both close to and at distances from the detonation points, measured the vertically-polarized component of the emitted pulse. Close to the explosion, attenuators were sometimes needed to prevent overloading, while at distances, amplifiers were needed. At all places, the pulse (in no case greater than 1 msec in length) was displayed on oscilloscope cathode ray tubes, and recorded photographically with either plate cameras triggered by the pulses or by strip film cameras started manually just before detonation times.

World-wide Timing. In order to assist in locating the pulse, particularly at distant locations where the energy was sometimes no greater than the noise, reliance at all stations was placed upon timing broadcasts from WWV (Washington, D. C.), WWVH (Maui, T. H.), JJY (Tokyo) or GBR (Rugby, England). To further assure a common time base, both GBR and WWV were recorded on the same film as a low frequency transmitter such as NSS (Annapolis, Maryland). This film was used for further correlation for instances where fading affected reception of WWV but did not affect reception of the high-powered low-frequency Navy traffic. In addition, all stations used locally-generated timing pulses coordinated with a world time station. The nuclear-device pulse and timing pips were presented on different beams of a multi-beam oscilloscope and photographed.

Local Timing. Annex A of Reference 3 has a detailed account of the National Bureau of Standards (NBS) local timing unit. A typical time record from a close-in station is shown in Figure 1 and one from a

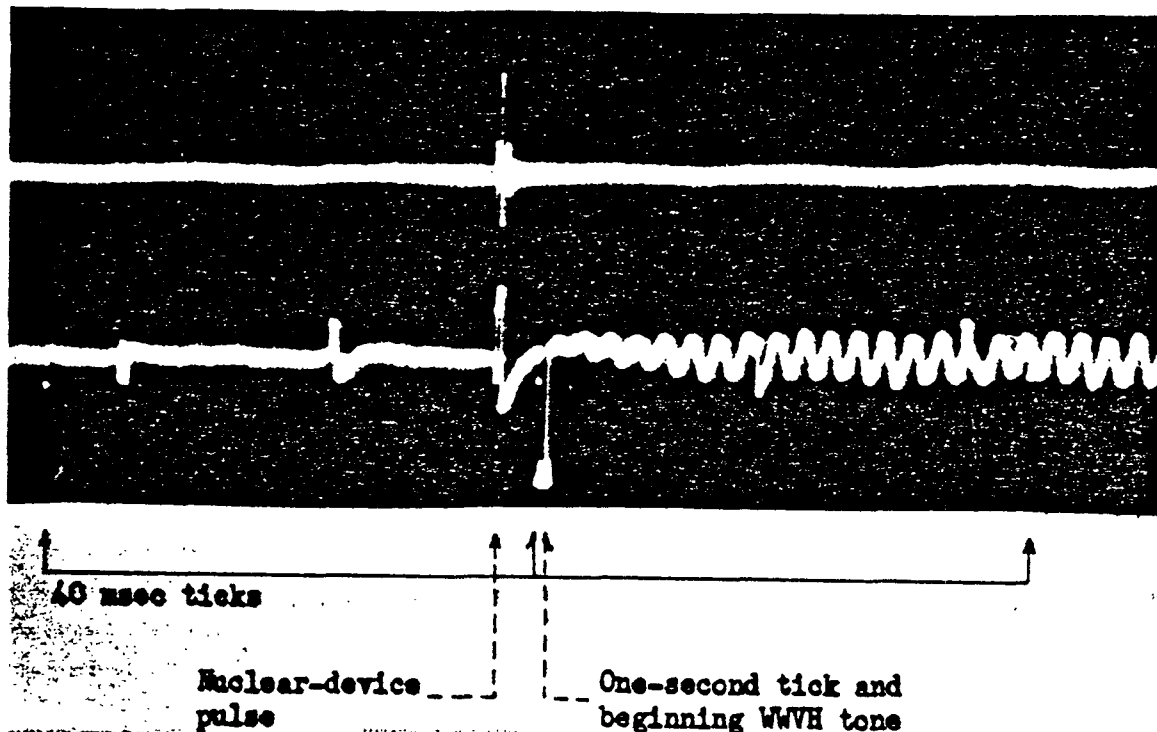

Figure 1 Timing traces recorded by NBS at Parry Island, Eniwetok Atoll.

distant station in Figure 2. Times of detonations could be read from the films to less than a millisecond; however, the world time at any station was limited by the accuracy of estimates for propagation time of the nuclear-device pulse, the timing pulses, or both. Effectively, this limited accuracy of world times to about  $\pm 1$  msec.

On Figure 1, the upper trace shows the electromagnetic nuclear-device signal as picked up on the broad-band receiver. The lower trace

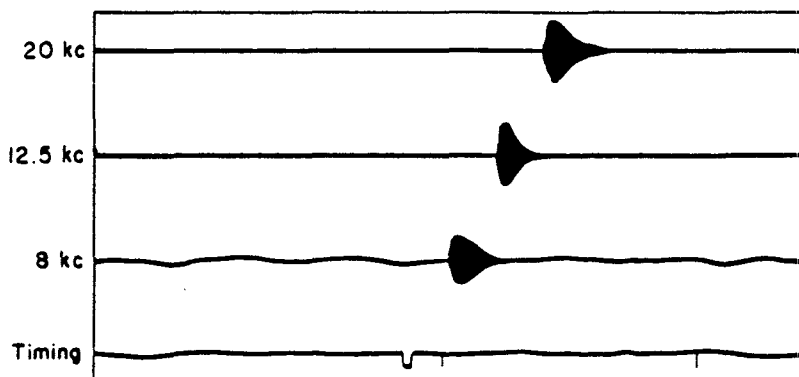

Figure 2 Typical NBS narrow-band field strength traces, with a timing trace recorded on a multi-beam oscilloscope at a distant location.

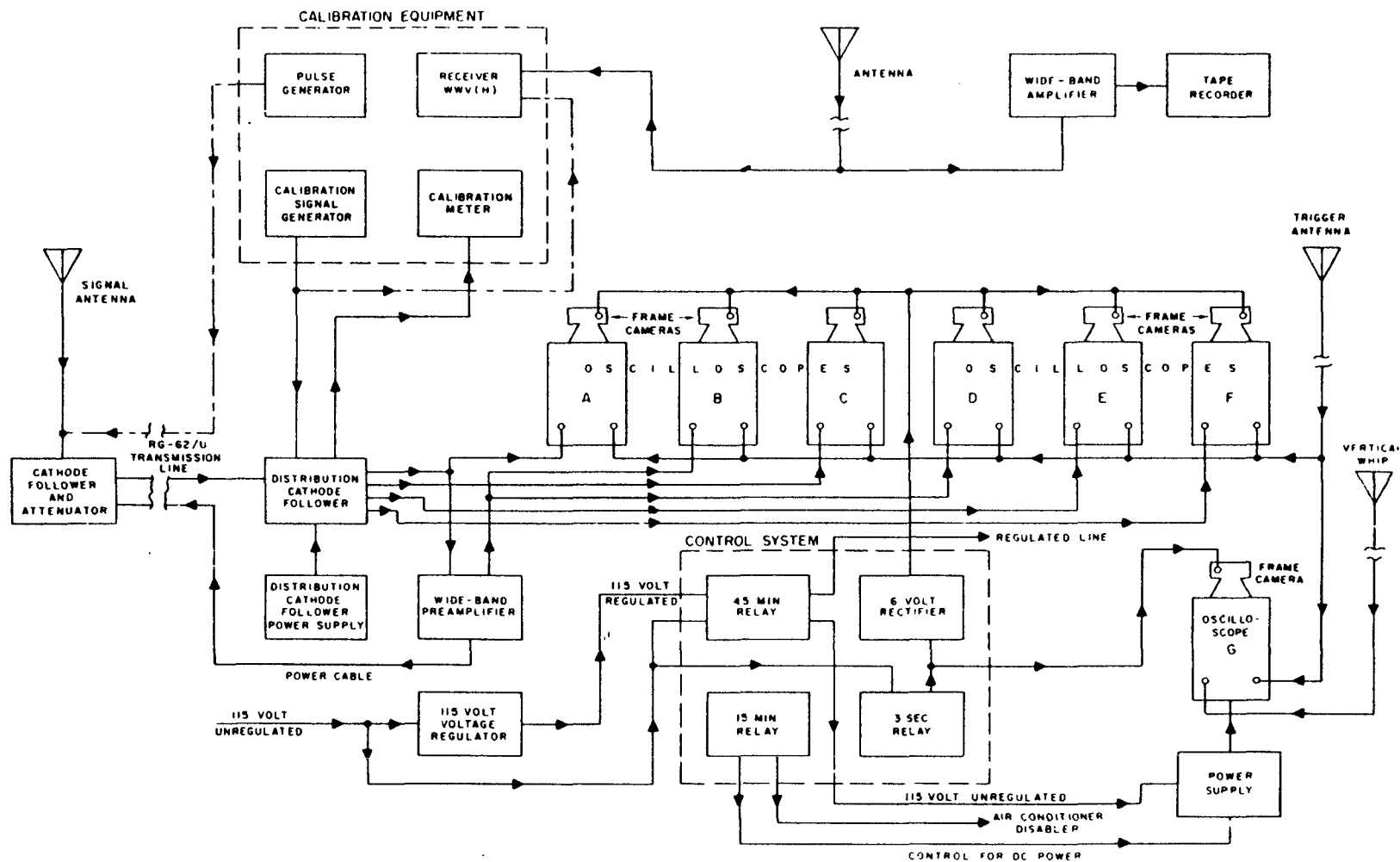

Figure 3 Block diagram showing the NBS close-in waveform instrumentation.

shows the WWVH signal and local synchronized time ticks superimposed. Note that the nuclear-device pulse was also picked up on the WWVH receiver. The specific second can be determined by counting WWVH second marks with reference to the missing 59th mark. Time in minutes and hours is noted from a chronometer synchronized with WWVH and the start of the camera. Detonation time from the record shown in Figure 1 was 28 February 1844:59.996Z; with corrections for propagation times of the nuclear-device signal and WWVH, the time is 1845:00.011Z.

National Bureau of Standards Close-in Station. At the close-in site, a vertical antenna 0.6 inch in diameter and 2 meters long was used and located about 60 meters from the recording equipment in order to minimize distortion due to radiation. At the base of the antenna a cathode follower fed a coaxial line to the recording instruments which consisted essentially of several oscilloscopes set at various sweep speeds and gains. At close distances (320 km) to ground zero, pulses were strong (several volts per meter) so there was no concern with interference from natural sources or transmitting stations. Consequently, the bandwidth of the pulses was limited only by the oscilloscopes. This limit was about 40 Mc for one type of oscilloscope used and about 13 Mc for the others. The low frequency limit was about 160 cps. A block diagram of the close-in waveform instrumentation is given in Figure 3.

Distant Stations. At distant points operated by NBS and the Defense Research Laboratory (DRL), 30-foot vertical antennae with standard cathode followers were used. Narrow-band (about 200 cps) and broad-band (about 1 to 70 kc) recordings were made. A ground mat 50 feet square was used at each location. The NBS narrow-band field strength traces, with a timing trace, were recorded on a multi-beam oscilloscope, as shown in Figure 2. Another oscilloscope and camera recorded the broad-band pulse. The DRL stations recorded the broad-band waveforms. The Air Weather Service (AWS) used a crossed-loop goniometer and recorded azimuths. In addition to other equipment, all distant NBS and DRL stations employed one standard recording channel with the same electrical characteristics. This channel, fed by a cathode follower, used a standard amplifier with a flat response over about 8 to 20 kc, and a gain of about 1,000. Reports by NBS (Reference 4) and DRL (Reference 5) should be consulted for further details.

The Air Weather Service operates a net of low-frequency (10 kc) narrow-band (about 0.5 kc) direction-finding stations for locating thunderstorm areas as an aid to weather forecasting. The equipment consists essentially of two identical amplifiers each fed by identical loops, one oriented north-south and the other east-west. The output of one amplifier is connected to the vertical plates and the other to the horizontal plates of an oscilloscope. The voltages add vectorially and the oscilloscope presentation shows a line indicating the direction of arrival of the pulse with a 180-degree ambiguity. To remove the ambiguity, a vertical antenna receiving the electric vector and driving the grid of the cathode ray tube through a third identical amplifier can be used to cancel a portion of the oscilloscope presentation. The azimuthal flashes on the oscilloscope face, together with 0.1-second and

1-second timing lights synchronized with WWV, are recorded on 35mm strip film. Further details are given in Technical Manuals (References 6,7).

The AFOAT-1 operational stations were essentially sferics direction-finding stations similar to the description above but with a wider bandwidth (8 to 12 kc). A coincidence system was used between Dow Air Force Base, Bangor, Maine and Austin, Texas so only signals in a pre-determined azimuth ( $\pm 5$  degrees) would present a distinctive mark on the film.

## OPERATIONS

Equipment. The equipment for the experiments at the Pacific Proving Ground was placed in a trailer and shipped as deck cargo. The trailer served as the main AFOAT-1 electromagnetic close-in station and contained all the equipment except that for determining world times of detonation. The trailer site selected was Enyu Island, on the southeastern portion of Bikini Atoll, and across the lagoon from the detonation points. The timing equipment was erected in the AFOAT-1 headquarters on Parry Island, Eniwetok Atoll.

Because of the expected high yield of Shot 1, the equipment on Enyu was not manned but was actuated by an Edgerton, Germeshausen and Grier (EGG) relay timer. The radioactive debris from Shot 1 drifted over the trailer, making it impossible to enter the area after the detonation until the debris had decayed to a reasonable value. After a week the trailer on Enyu had cooled sufficiently for handling, so all equipment was removed and relocated on Runit Island, Eniwetok Atoll, about 300 km from Bikini. The equipment was installed in a bunker on Runit where it was manned for the balance of the Bikini shots. For Shot 6, which was detonated on Eniwetok, 23 km from the bunker, the recording equipment on Runit was unmanned but was actuated by an EGG relay timer.

Station Locations. Figure 4 shows the locations of the electromagnetic stations, the agency responsible for the measurements at each place, and the distances from each station to Bikini and Eniwetok. For the most part for distant stations, locations already in use by NBS, DRL, AWS and AFOAT-1 were utilized. At Shemya, Thule and Kirknewton, however, site surveys were made by AFOAT-1 personnel. Insofar as possible, sites were chosen on east-west and north-south orientations in an attempt to get some idea of the propagation differences due to a daylight path, a dark path, and auroral zone transmission.

Special Measurements. Between detonations, low-frequency transmitters, NSS (Annapolis, Maryland), NLK (Arlington, Washington), NPM (Oahu, T.H.), and GER (Rugby, England) were monitored on an agreed-upon schedule, in order to obtain information on various transmission paths at various times. There was also an attempt to monitor sferics to coincide with the routine AWS four-minute recording scheduled every six hours, beginning at 0030Z.

Alert Notifications. The experimental equipment installed at the close-in locations, and at most of the distant locations, had a limited

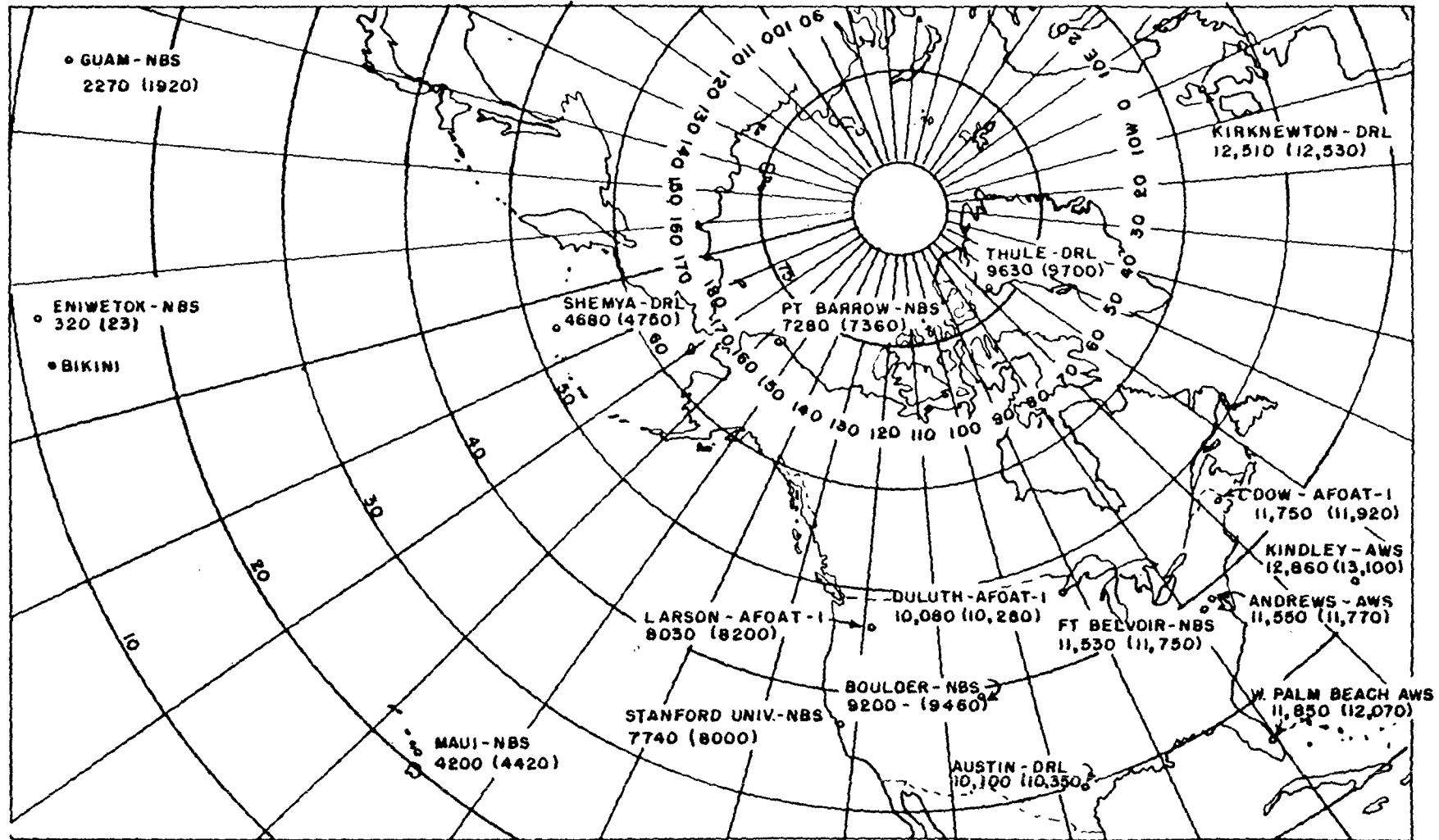

Figure 4 Pertinent information on Castle electromagnetic stations. Information includes station locations; sponsoring agencies; and approximate distances, in kilometers, from Bikini and Eniwetok (figures in parentheses). NBS, National Bureau of Standards; DRL, Defense Research Laboratory; AWS, Air Weather Service; AFOAT-1, Air Force Office for Atomic Energy.

recording time (in some cases, a few seconds). In order to coordinate global operations, the day-to-day changes in schedule were sent to the several sites over regular military TWX or commercial telephone circuits. The messages were in code when schedule information was sent. In addition to schedule changes, the alert communication code was used to give estimated field strengths for the various shots and thus assist station personnel in setting amplifier gains.

Low-frequency Interference. The distant stations at Fort Belvoir, Virginia and Maui, T. H. were less than 100 km from the Naval transmitters, NSS and NPM, respectively. Both transmitters use carriers (16 to 20 kc) that would interfere with broad-band recordings of a nuclear-device detonated thousands of kilometers away. Through the cooperation of the Navy, NPM, NSS and NLK were off the air at shot times. For security purposes these transmitters were also frequently taken off the air at other than shot times.

## RESULTS AND OBSERVATIONS

There was a total of 17 stations participating, although for any one shot no more than 15 stations were in operation. A summary of the results at the various locations is given in Table 1.

The detonation time was determined from the timing equipment on Parry Island, Eniwetok Atoll.

One of the means of locating the nuclear-device pulse when recorded at distances from the test site is by knowledge of the time of detonation. Where millisecond accuracy was possible, the agreement, with one exception, was within 2 msec of the Parry Island time after corrections for propagation and WWV times were made. Some equipment did not have the capability of resolving time to within a few milliseconds, as indicated by asterisks in Table 1.

Azimuthal errors are generally within the error experienced with this type of very low frequency (VLF) equipment, namely,  $\pm 3$  degrees.

Teller Light. An experiment at the Runit Island location, designed to record the Teller Light and the electromagnetic pulse simultaneously, failed on Shots 2, 3, 4, and 5 because of the distance from Bikini, and on Shot 6 because of equipment malfunctions. The purpose of this experiment was to establish an electromagnetic fiducial in time coincident with other phenomena.

Field Strengths. For a given path, the attenuation is determined by distance, reflection coefficients of the ionosphere (day, night, sunrise or sunset along the path), and ground conductivities. In addition, some workers have reported variations for east-west or north-south paths. (See the comments about the low-frequency transmitters later in this report.) All the above effects vary with frequency.

Up until Castle, close-in measurements had been made of the ground wave at the Nevada Test Site at distances between 20 and 50 km, which was within line-of-sight of the detonation areas (References 1,3). An attempt was made to obtain measurements at comparable distances during this series; however, because of the radioactive fallout from Shot 1,

TABLE 1 SUMMARY OF CASTLE RESULTS

Station/Agency Distance (km) and calculated azimuths to Bikini (B) and Eniwetok (E)	Time as received at the station (Z), corrected for nuclear detonation pulse and WWV transmission times; Remarks; Recorded azimuths to detonation points; Field Strength data (v/m); a. Broad-band, center-to-peak (W whip, L loop); b. Narrow-band.	
	Shot 1 - 28 February 1954 - 1845:00.011Z Detonated at Bikini	Shot 2 - 26 March 1954 - 1830:00.378Z Detonated at Bikini
Eniwetok/NBS B 20 and 320 E 23	Radioactive debris fogged waveform equipment on Enyu Island, Bikini Atoll (20 km from detonation point).	1830:00.378 Waveform equipment was moved to Runit Island, Eniwetok for the balance of the series. a. ~21.0 (W)
Guam/NBS B 2,270 E 1,920	1845:00.011 a. 0.74 (W)	1830:00.378 a. 1.54 (W) b. 0.036 (8 kc) 0.042 (12.5 kc) 0.023 (20 kc)
Maui/NBS B 4,200 E 4,420	1845:00.010 a. 1.77 (W) b. 0.23 (8 kc) 0.26 (12.5 kc) 0.026 (20 kc)	No time record. a. 1.79 (W)
Shemya/DRL B 4,680; 209° E 4,750; 214°	Alert notification not received in time.	1830:00.376 a. 0.054 (L) 210° ±3°
Ft. Barrow/NBS B 7,280 E 7,360	Poor timing record. a. 0.52 (W)	1830:00.378 a. 0.61 (W) b. 0.010 (8 kc) 0.011 (12.5 kc) 0.00097 (20 kc)
Stanford Univ/NBS B 7,740 E 8,000	Not in operation.	1830:00.377 a. 0.42 (W) b. 0.020 (8 kc) 0.018 (12.5 kc) 0.0018 (20 kc)
Larson AFB/AF B 8,030; 267° E 8,200; 269°	Off scale. 270° ±3°	1830:00.5 * 271° ±3°
Boulder/NBS B 9,200 E 9,460	1845:00.012 a. 0.38 (W) b. 0.014 (8 kc) 0.16 (12.5 kc) 0.0015 (20 kc)	1830:00.379 a. 0.34 (W) b. 0.016 (12.5 kc) 0.0015 (20 kc)
Thule/DRL B 9,630; 307° ±1° E 9,700; 310° ±1°	Alert notification not received in time.	1830:00.378 a. ~ 0.02 (W) 310° ±3° 0.025 (L)
Duluth/AF B 10,080; 287° E 10,280; 289°	Not in operation.	Not in operation.
Austin/DRL B 10,100; 282° ±1° E 10,350; 284° ±1°	1845:00.011 a. 0.68 (W) 287° ±3° 0.083 (L)	1830:00.378 a. 1.10 (W) 0.13 (L)
Ft Belvoir/NBS B 11,530 E 11,750	1845:00.011 b. 0.006 (8 kc) 0.0044 (12.5 kc)	1830:00.378 a. 0.080 (W) b. 0.0054 (8 kc) 0.0052 (12.5 kc) 0.00078 (20 kc)
Andrews/AWS B 11,550; 296° E 11,770	Not in operation.	1830:00.32 * 300° ±3°
Dow AFB/AF B 11,750; 301° E 11,920	Equipment trouble.	1830:00.35 * 295° ±3°
W Palm Beach/AWS B 11,850; 291° E 12,070	1845:00.00 * 299° ±3°	1830:00.37 * 294° ±3°
Kirknewton/DRL B 12,510; 12° E 12,530; 17°	Alert notification not received in time.	Poor time correlation. 19° ±3° a. 0.049 (W)
Kindley AFB/AWS B 12,860; 302° E 13,100	1844:59.58 * 308° ±3°	Not in operation.

\*Within limit of resolution.

TABLE 1 SUMMARY OF CASTLE RESULTS (Cont)

Station/Agency Distance (km) and calculated azimuths to Bikini (B) and Eniwetok (E)	Time as received at the station (Z), corrected for nuclear detonation pulse and WWV transmission times; Remarks; Recorded azimuths to detonation points; Field Strength data (v/m); a. Broad-band, center-to-peak (W whip, L loop); b. Narrow-band.					
	Shot 3 - 6 April 1954 - 1820:00.411Z Detonated at Bikini			Shot 4 - 25 April 1954 - 1810:00.691Z Detonated at Bikini		
Eniwetok/NBS B 20 and 320 E 23	1820:00.411	a. ~15.0	(W)	1810:00.691	a. ~40.0	(W)
Guam/NBS B 2,270 E 1,920	1820:00.412	a. 0.61 b. 0.0034 (8 kc) 0.0065 (12.5 kc) 0.0080 (20 kc)	(W)	1810:00.692	a. 1.06 b. 0.023 (8 kc) 0.043 (12.5 kc) 0.020 (20 kc)	(W)
Main/NBS B 4,200 E 4,420	1820:00.412	a. 0.27 b. 0.010 (8 kc) 0.013 (12.5 kc) 0.0013 (20 kc)	(W)	No time record.	a. 1.49	(W)
Shemya/DRL B 4,680; 209° E 4,750; 214°	Alert notification not received in time.			1810:00.689	a. 0.039 214° ±3° 0.33	(W) (L)
Ft. Barrow/NBS B 7,280 E 7,360	Poor time record.			No time record.	a. 0.29	(W)
Stanford Univ/NBS B 7,740 E 8,000	1820:00.412	a. 0.048 b. 0.0023 (8 kc) 0.0033 (12.5 kc) 0.0020 (20 kc)	(W)	1810:00.691	a. 0.33 b. 0.0055 (8 kc) 0.0087 (12.5 kc) 0.0012 (20 kc)	(W)
Larson AFB/AF B 8,030; 267° E 8,200; 269°	Record not available.			Doubtful record.		
Boulder/NBS B 9,200 E 9,460	1820:00.412	a. 0.055 b. 0.0011 (8 kc) 0.0028 (12.5 kc) 0.00031 (20 kc)	(W)	1810:00.690	a. 0.33 b. 0.0080 (8 kc) 0.018 (12.5 kc) 0.0011 (20 kc)	(W)
Thule/DRL B 9,630; 307° ±1° E 9,700; 310° ±1°	1820:00.411 314° ±3°	a. 0.0035 0.0012	(W) (L)	1810:00.691 307° ±3°	a. 0.046 0.025	(W) (L)
Duluth/AF B 10,080; 287° E 10,280; 289°	Not in operation.			Record not available.		
Austin/DRL B 10,100; 282° ±1° E 10,350; 284° ±1°	1820:00.411 285° ±3°	a. 0.027 0.016	(W) (L)	1810:00.691 288° ±3°	a. 0.27 0.12	(W) (L)
Ft Belvoir/NBS B 11,530 E 11,750	1820:00.412	a. 0.016 b. 0.00075 (8 kc) 0.001 (12.5 kc) 0.00022 (20 kc)	(W)	1810:00.690	a. 0.090 b. 0.0021 (8 kc) 0.0055 (12.5 kc) 0.00062 (20 kc)	(W)
Andrews/AWS B 11,550; 296° E 11,770	Results negative.			1810:00.69	294° ±3°	*
Dow AFB/AF B 11,750; 301° E 11,920	Results negative.			Heavy sferics activity.		
W Palm Beach/AWS B 11,850; 291° E 12,070	Started too late.			Not in operation.		
Mirknewton/DRL B 12,510; 12° E 12,530; 17°	1820:00.411 29° ±3°	a. 0.013 0.003	(W) (L)	1810:00.692 22° ±3°	a. 0.0096 0.0059	(W) (L)
Kindley AFB/AWS B 12,860; 302° E 13,100	Not in operation.			Not in operation.		

\*Within limit of resolution.

TABLE 1 SUMMARY OF CASTLE RESULTS (Cont)

Station/Agency Distance (km) and calculated azimuths to Bikini (B) and Eniwetok (E)	Time as received at the station (Z), corrected for nuclear detonation pulse and WW transmission times; Remarks; Recorded azimuths to detonation points; Field Strength data (v/m); a. Broad-band, center-to-peak (W whip, L loop); b. Narrow-band.					
	Shot 5 - 4 May 1954 - 1810:00.156Z Detonated at Bikini			Shot 6 - 13 May 1954 - 1820:00.404Z Detonated at Eniwetok		
Eniwetok/NBS B 20 and 320 E 23	1810:00.156	a. ~34.0	(W)	1820:00.404	a. ~775.0	(W)
Guam/NBS B 2,270 E 1,920	1810:00.154	a. 1.45 b. 0.090 0.047 0.029	(W) (8 kc) (12.5 kc) (20 kc)	1820:00.404	a. ~1.46 b. 0.035 0.028 0.041	(W) (8 kc) (12.5 kc) (20 kc)
Mani/NBS B 4,200 E 4,420	1810:00.156	a. 1.31 b. 0.12 0.056 0.011	(W) (8 kc) (12.5 kc) (20 kc)	1820:00.404	a. 1.44	(W)
Shemya/DRL B 4,680; 209° E 4,750; 214°	1810:00.155 215° ±3°	a. 0.073 0.42	(W) (L)	1820:00.401 210° ±3°	a. 0.037 0.38	(W) (L)
Pt Barrow/NBS B 7,280 E 7,360	1810:00.158	a. 0.35 b. 0.013 0.014 0.0011	(W) (8 kc) (12.5 kc) (20 kc)	No time record.	b. 0.013 0.014 0.0011	(8 kc) (12.5 kc) (20 kc)
Stanford Univ/NBS B 7,740 E 8,000	No record			1820:00.405	a. 0.51 b. 0.012 0.019 0.00097	(W) (8 kc) (12.5 kc) (20 kc)
Larson AFB/AP B 8,030; 267° E 8,200; 269°	Poor signal			1820:00.3 272° ±3°		
Boulder/NBS B 9,200 E 9,460	1810:00.158	b. 0.013 0.014 0.00057	(8 kc) (12.5 kc) (20 kc)	1820:00.405	a. 0.30 b. 0.0068 0.017 0.0017	(W) (8 kc) (12.5 kc) (20 kc)
Thule/DRL B 9,630; 307° ±1° E 9,700; 310° ±1°	1810:00.157 308° ±3°	a. 0.041 0.032	(W) (L)	1820:00.404 310° ±3°	a. 0.071 0.028	(W) (L)
Daluth/AP B 10,080; 287° E 10,280; 289°	1810:00.17 288° ±3°			1820:00.3 288° ±3°		
Austin/DRL B 10,100; 282° ±1° E 10,350; 284° ±1°	1810:00.158 286° ±3°	a. 0.259 0.14	(W) (L)	1820:00.405 291° ±3°	a. 0.24 0.13	(W) (L)
Pt Belvoir/NBS B 11,530 E 11,750	1810:00.158	a. 0.070 b. 0.0037 0.0040 0.00031	(W) (8 kc) (12.5 kc) (20 kc)	1820:00.405	a. 0.078 b. 0.0020 0.0056 0.00084	(W) (8 kc) (12.5 kc) (20 kc)
Andrews/AWS B 11,550; 296° E 11,770	1810:00.17 298° ±3°			Not in operation.		
Dow AFB/AP B 11,750; 301° E 11,920	Record not available.			1820:00.2		
W Palm Beach/AWS B 11,850; 291° E 12,070	1810:00.14 292° ±3°			Not in operation.		
Kirknewton/DRL B 12,510; 12° E 12,530; 17°	1810:00.158 26° ±3°	a. 0.0086 0.0063	(W) (L)	1820:00.404 21° ±3°	a. 0.012 0.0070	(W) (L)
Kindley AFB/AWS B 12,860; 302° E 13,100	1810:00.18 306° ±3°			Not in operation.		

\* Within limit of resolution.

the station was moved to Eniwetok Atoll, about 320 km from the Bikini detonation locations. The Shot 6 detonation point was within line-of-sight, but the records obtained were of questionable value, probably because of spurious pick-up on lead-ins.

Since most of the electromagnetic energy recorded from a nuclear detonation is in the VLF band, the ground waves recorded at 320 km have substantially the same shape as a closer recording with, of course, a decrease in magnitude. For example, from References 8 and 9, decreases in ground wave amplitude to be expected over a sea water path between two locations 23 km and 320 km from the origin vary with frequency as follows: 1 kc, 27 db; 10 kc, 24 db; 500 kc, 29 db; 2 Mc, 33 db; and 5 Mc, 39 db.

At distances, where no ground wave was recorded, the wave shape was an additive combination of more than one sky wave, and the result was usually similar to a damped sinusoid with higher frequencies attenuated relatively more. From Reference 10, for a typical daylight path, sky-wave attenuation in decibels per 1,000 km is about 20 at 1 kc, about 2 at 10 kc and then rises gradually to about 50 at 1 Mc.

Field strength, especially at distant points, is only a very approximate measure of yield. However, a rough estimate of yield within about an order of magnitude may be obtained from broad-band field-strength measurements. Figure 5 is a plot of field strengths from the Castle shots for stations on an east-west path recording broad-band waveforms. Probable curves are drawn in for three of the stations. Figure 6 is a plot of field strengths of three stations on a north-south path. Field strength data from Guam, Shemya and Pt. Barrow are generally low. The reasons are not definitely known and these anomalies are being investigated. Contributing causes may be interference between sky-wave modes, ionospheric absorption, ground constants, and, in the case of Pt. Barrow, attenuation due to auroral absorption. It is believed that the Shemya field strength data, additionally, may be low because of local conditions at the receiving site.

Records. Figures 7 through 12 are selected Castle electromagnetic records (References 4,5). Records from all shots recorded are shown from Eniwetok; Guam; Maui, T. H.; Boulder, Colorado; and Ft. Belvoir, Virginia to illustrate changes with distance. Additionally, some typical records from other locations are reproduced.

At Eniwetok, for Shots 2, 3, 4 and 5, the sweep time was long enough to record not only the ground wave, but also one or more sky waves (Figures 8, 9, 10, 11). At Guam, for Shot 3 (Figure 9), several sky waves are shown.

Close-in waveforms are broad band. The oscilloscopes had the capability of faithfully recording frequencies in the range from essentially dc to 13 Mc. This was more than adequate, since the maximum equivalent frequency recorded was about 3 or 4 Mc. Two broad-band vertical electric component waveforms are included for each shot, except Shot 1. when all film on Enyu was exposed to radiation.

At least at a distance of 320 km some detail is preserved in the first hop sky wave (Figure 9, Eniwetok). The arrival times of the first

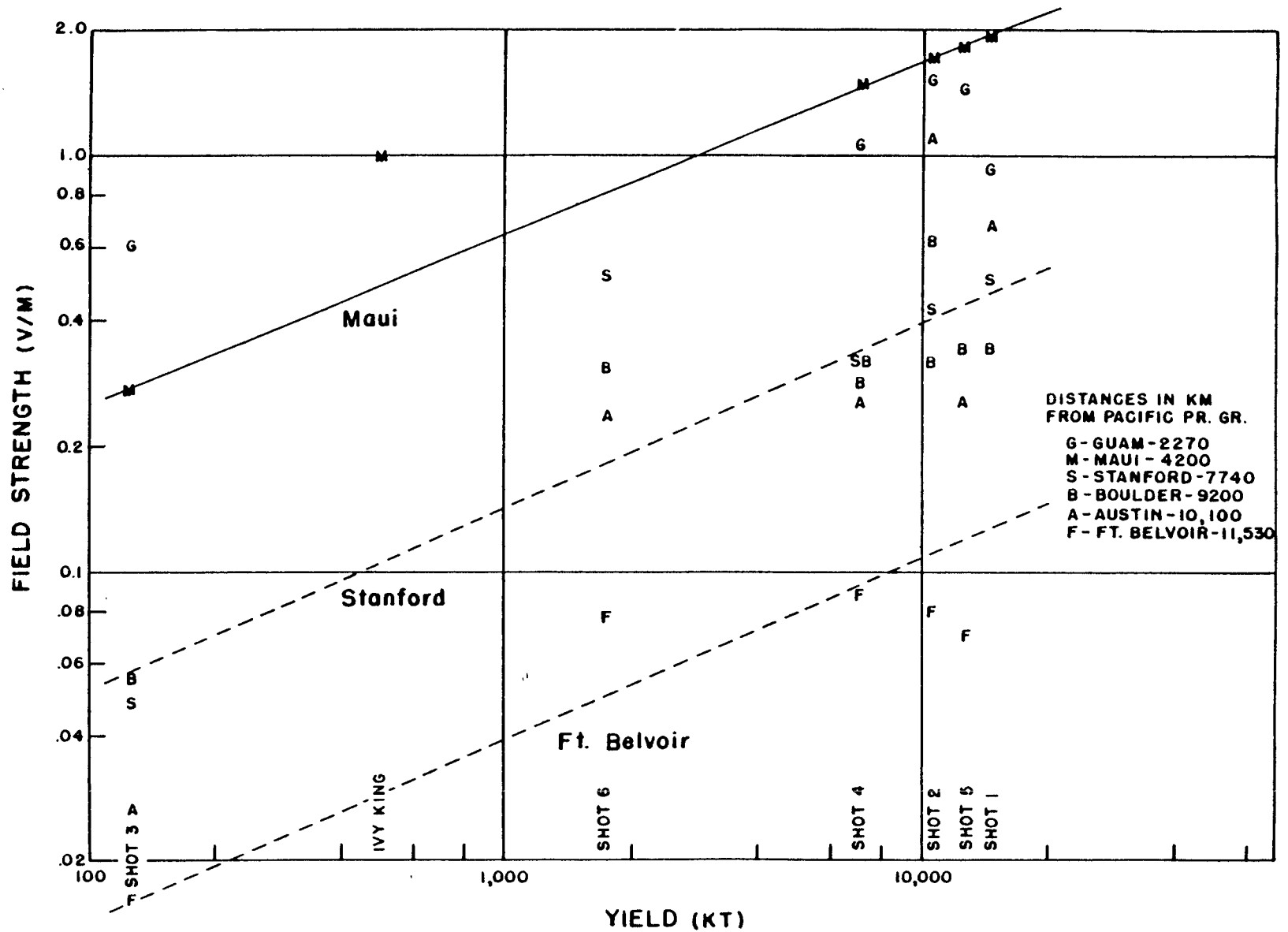

Figure 5 Plot of selected Castle data showing the relationship between peak field strength and yield on an east-west path. Probable curves, drawn by inspection, are shown for Maui, Stanford University and Ft. Belvoir.

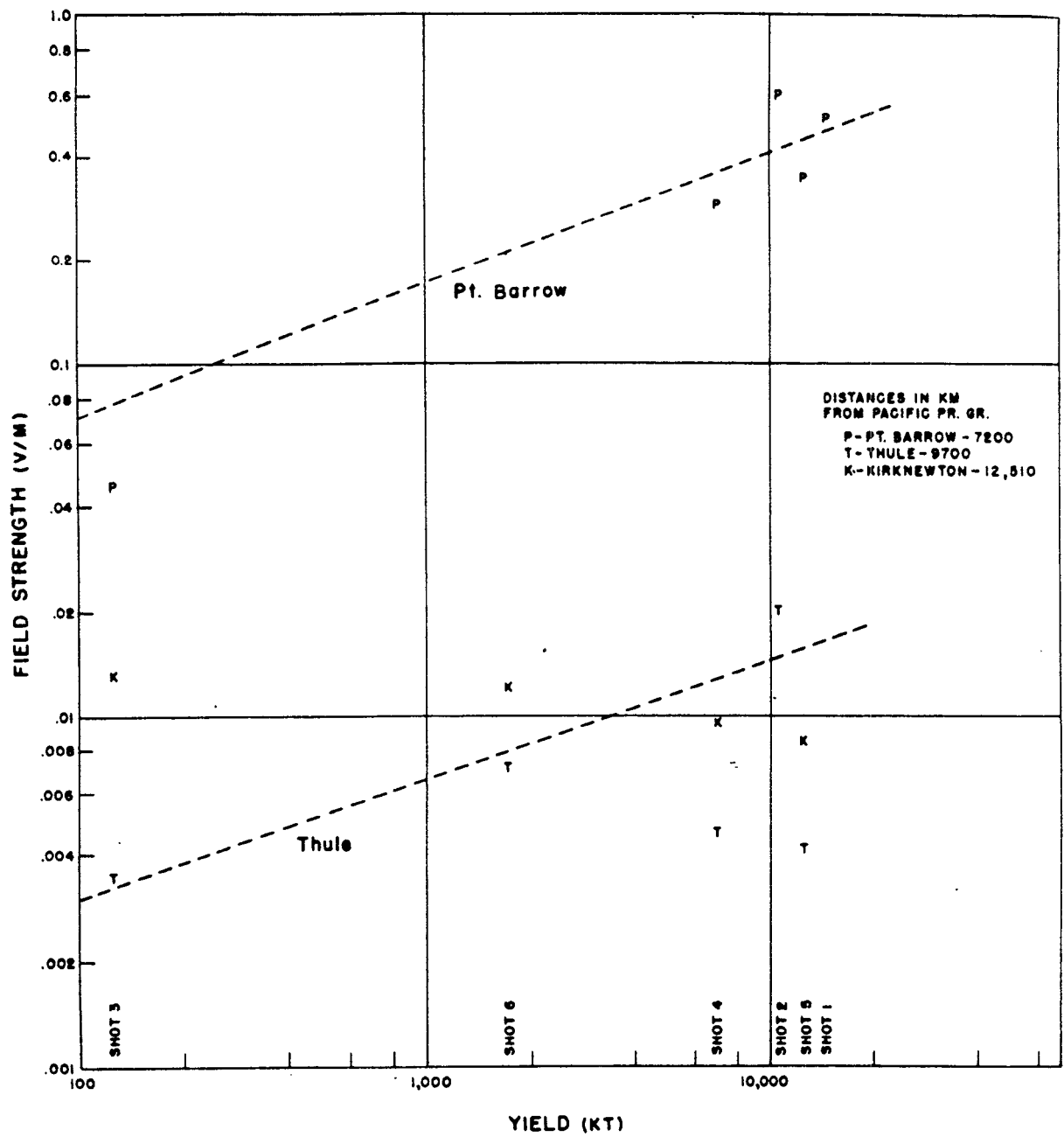

Figure 6 Plot of selected Castle data showing the relationship between peak field strength and yield on a north-south path. Probable curves, drawn by inspection, are shown for Ft. Barrow and Thule.

sky wave give an ionospheric layer height of about 90 km. Some records (not included in this report) show as many as five sky waves, but of course with less energy for each reflection, and they also indicate an ionospheric layer height of about 90 km. All close-in records show the characteristic first negative-going pulse;

The close-in records from Shot 6 (23 km away) appear to have spurious components imposed. This could be pick-up on lead-ins or through the earth. Other experiments at comparable distances at the Nevada Test Site have all involved detonations almost two orders of magnitude lower in energy.

The changes in waveform due to the filtering effects of the ionosphere (absorption of the higher frequency components) and interference between different sky-wave modes is quite apparent as the broad-band pulse is recorded at greater distances; the pulse loses character and presents a damped sine wave appearance. Broad-band waveforms at the far stations, in general, mean about 6 to 100 kc, which encompasses the greatest portion of the energy available.

Fourier Analyses. The National Bureau of Standards has performed Fourier analyses of two of the Castle shots (References 11,12). The transform

$$g(f) = \int_0^{\infty} E(t) e^{-2\pi f t} dt \quad (1)$$

has been computed by using the values of field strength tabulated as a function of time and performing the integration numerically on the SEAC. The magnitude of  $g(f)$  (the square root of the sum of the squares of the real and imaginary parts) for the Shot 2 pulse, as received at some NBS sites, has been plotted as a function of frequency in Figure 13.

In order to evaluate absorption due to earth and ionospheric losses, a distance factor is employed. For short distances this is the inverse of the distance, but for longer distances, the earth's curvature is taken into account, assuming that the ionosphere and the earth act as a wave guide. From Reference 10, the factor is

$$\sqrt{\sin \frac{D}{R}} \quad (2)$$

Where:  $D$  = Distance from the origin, (km).  
 $R$  = Earth's radius, (km).

Figure 14 is a plot of the Shot 2 pulse, but the spectral intensity  $C$ , which is proportional to the amplitude of the received field strength per cycle of bandwidth is multiplied by  $\sqrt{\sin \frac{D}{R}}$ . Figure 15 is a similar plot for Shot 3. Some propagation characteristics may be deduced from Figures 14 and 15. For Shot 3, 126 kt, the peak frequencies of Figure 15 decrease from about 18 kc for Eniwetok (320 km) to 11 kc for Ft. Belvoir, Virginia (11,530 km). However, in the case of Shot 2, with a yield of 10.5 Mt, the peak frequency of Figure 14 re-

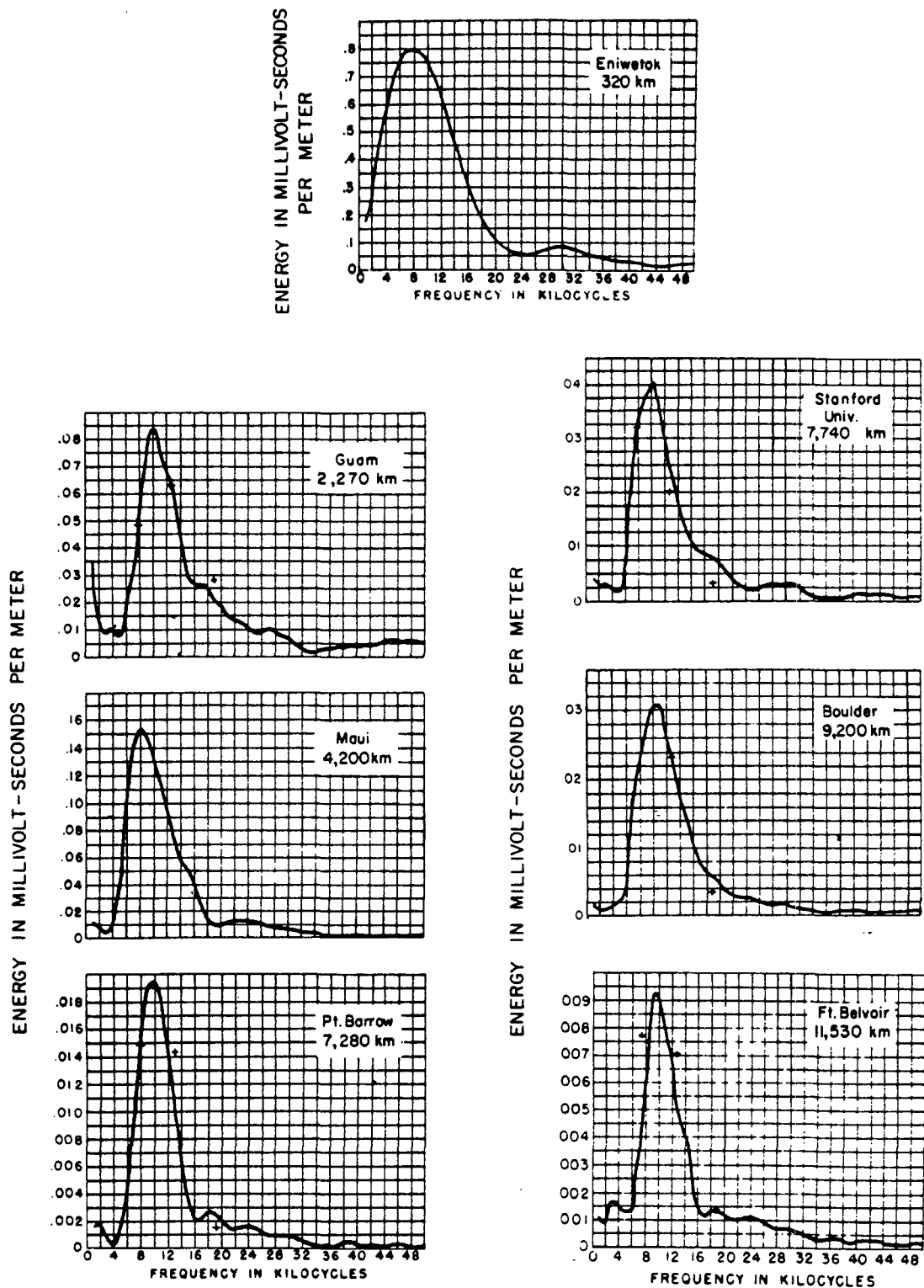

Figure 13 Broad-band spectral curves for Shot 2 as received at the NBS stations. Narrow-band points are indicated by crosses.

mains very nearly the same as the pulse is propagated to distances. This is partially because the distribution of energy with frequency near the source was different for Shot 3 and Shot 2. The curves also show attenuation with distance at any frequency within the range analyzed. It is apparent that the higher frequencies are attenuated relatively more. It is interesting to compare Figure 13, which shows spectral intensity values as received for Shot 2, and Figure 14, which shows comparable values with the distance factor removed. Under the conditions of the Castle tests, as distance increases, attenuation due to distance becomes relatively less important.

Yield and Predominant Frequency. There appears to be an approximate relationship between yield and frequency at which peak energy occurs, and there is some theoretical justification for this relationship (Reference 13). Plotted as Figure 16 is a theoretical curve from Reference 13, with points indicating frequencies with maximum energy, as calculated from close-in waveforms, for some of the Upshot-Knothole detonations, Castle Shots 2 and 3, and estimated frequencies for Castle Shots 4, 5, and 6.

Narrow-Band Records. Narrow-band (approximately 200 cps) recordings were also made during the Castle series. This technique may be necessary in making measurements under operational conditions. Values of spectral intensity were also calculated for field strength narrow-band values received for Shot 2 (Reference 11). Figure 13 has narrow-band points indicated by crosses and it will be noted that in most cases, the agreement with the corresponding broad-band spectral curve is quite good. In some cases, the trigger level was somewhat high, which resulted in missing the initial portion of the waveform. Other reasons for discrepancies were variation in bandwidth with signal level and aging of tubes.

Peripheral Lightning Flashes. Fast-frame moving picture photography (3,000 or more frames per second) of Ivy Mike show what appears to be lightning flashes between the natural cloud cover and the sea on the periphery of the fireball. This phenomena starts at about 5 msec after the beginning of the nuclear reaction and continues for about 75 msec or more. These visible flashes were also evident on the high-speed photographic film recordings of the Castle series.

High-gain receiving equipment, with a bandwidth of about 1 kc to 1 Mc, long-wire antenna, and a tape recorder were used at Eniwetok in an attempt to detect these flashes. No signals attributable to the discharges were noted.

Low-Frequency Transmitters. An analysis of field strength measurements of low-frequency transmitters has been carried out by NBS. (References 4,12) At widely-separated locations during Castle, NBS and DRL monitored NSS, NLK, NPM and GBR to obtain field strength measurements. Narrow-band equipment was used; essentially the same as that used for recording the narrow-band field strengths from nuclear detonations. Measurements were made at the same time at each location, once each hour. Five selected plots of field strength versus time from

7E

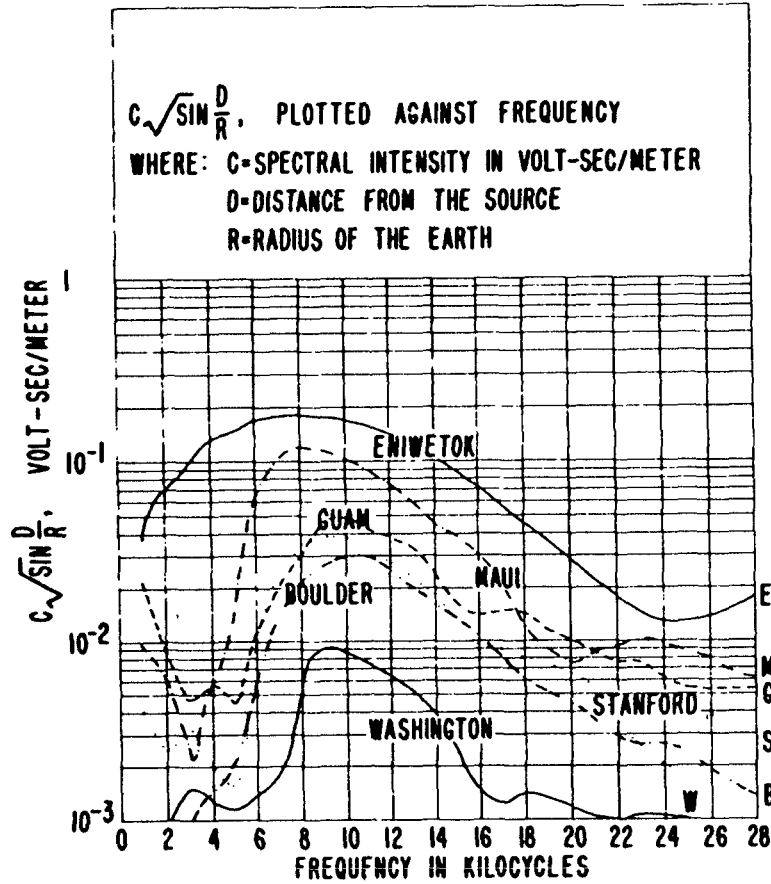

Figure 14 Spectral intensity, as a function of frequency, for Shot 2 as received at selected NBS stations.

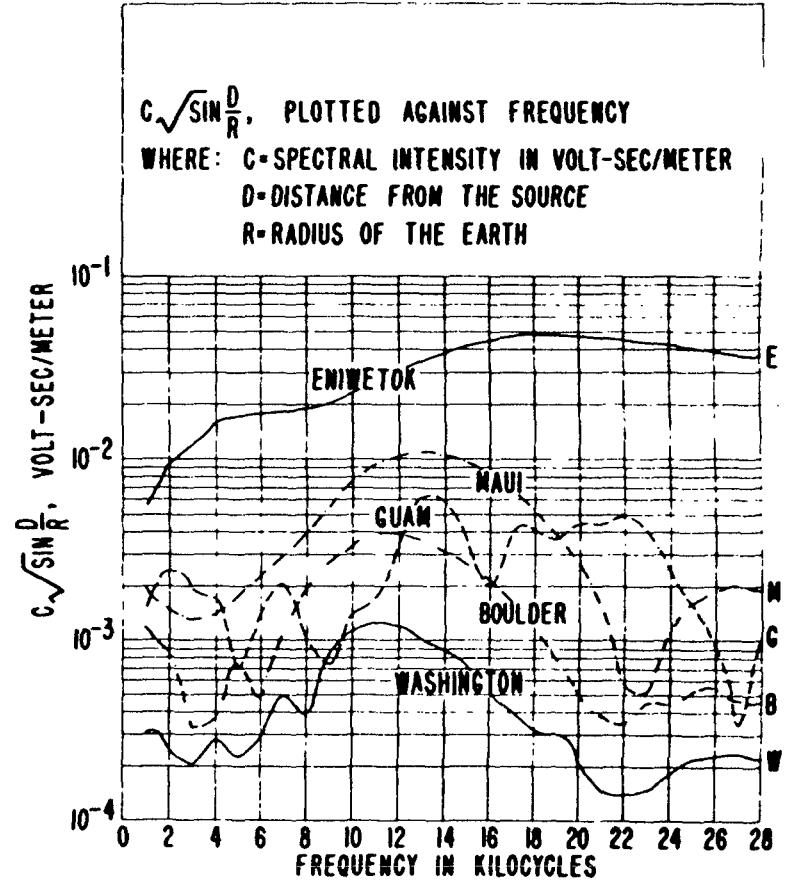

Figure 15 Spectral intensity, as a function of frequency, for Shot 3 as received at selected NBS stations.

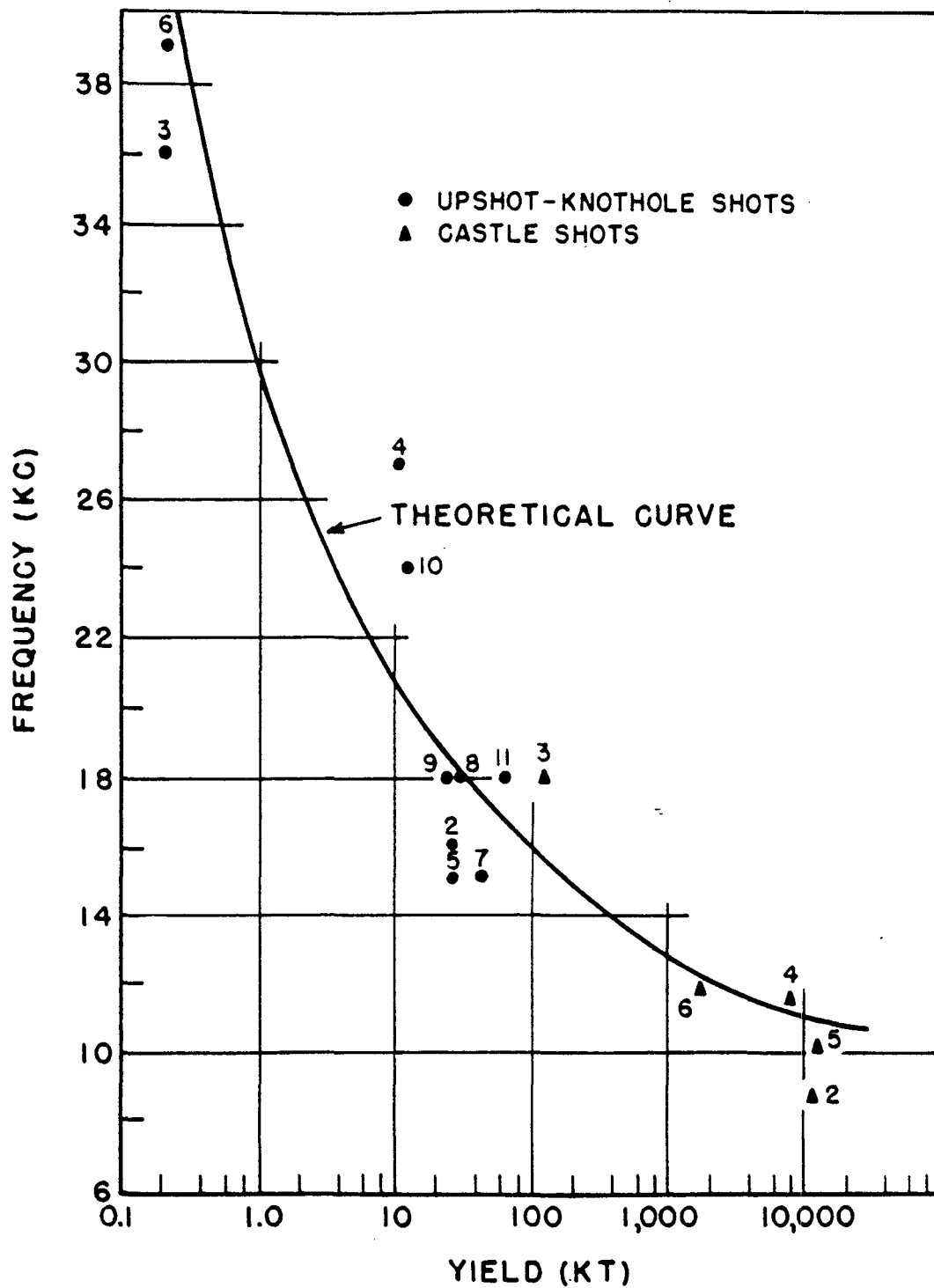

Figure 16 Plot of selected Upshot-Knothole and Castle close-in waveforms showing the relationship between yield and predominant frequency.

Reference 12 are reproduced here. Figures 17 and 18 show the field strengths of NSS as measured by DRL at Kirknewton, Scotland and Thule, Greenland, respectively. These are essentially north-south paths, with that to Kirknewton skirting the auroral zone, and that to Thule penetrating the auroral zone. Figure 19, for the NPM-Thule path, is also north-south penetrating the auroral zone. Figures 20 and 21 are plots of the field strengths of NPM and NSS, as measured by DRL at Austin on the same days and at the same times. These data are for an east-west path.

It is readily apparent that there was considerable variation in recorded field strengths from day-to-day and during the day. Day and night variations in signal strength are generally more pronounced on the north-south path than east-west. The magnitude of diminution in

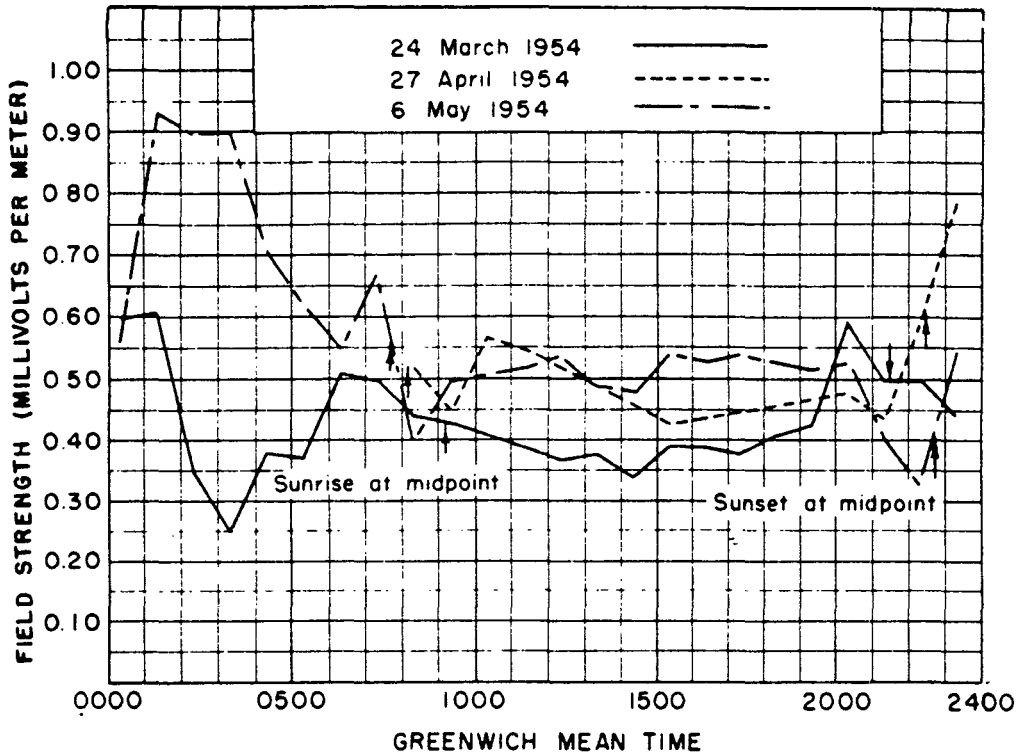

Figure 17 Plot of the field strength of NSS as measured by DRL at Kirknewton, Scotland.

signal from dark-to-daylight paths was apparently greater when the auroral zone was penetrated. At Thule and Austin field strengths were lower during magnetically disturbed periods (i.e. 24 March 1954) than during relatively quiet magnetic periods (i.e. 6 May 1954). Magnetic factors from the Cheltenham Magnetic Observatory were used as criteria.

The average daytime field strength from NSS at Kirknewton (5,800 km) was about 0.45 mv/m, while at Thule (4,000 km), it was about 0.03 mv/m. If equal attenuation per 1,000 km is assumed for both paths, then NSS-Thule is low by 25 to 30 db as compared with NSS-Kirknewton.

The NPM-Austin path on 24 March, 27 April and 6 May 1954 showed higher day and night field strengths during magnetically disturbed periods than when comparatively quiet. This is an apparent disagreement with the NSS-Thule and NSS-Kirknewton results; however, it is in

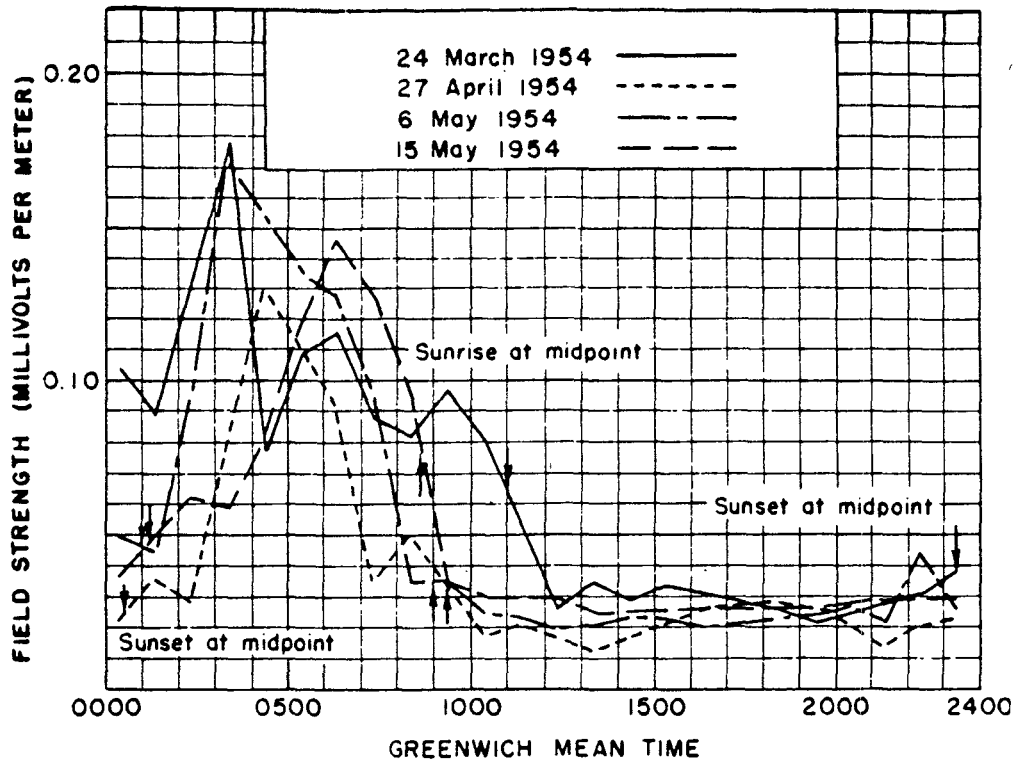

Figure 18 Plot of the field strength of NSS as measured by DRL at Thule, Greenland.

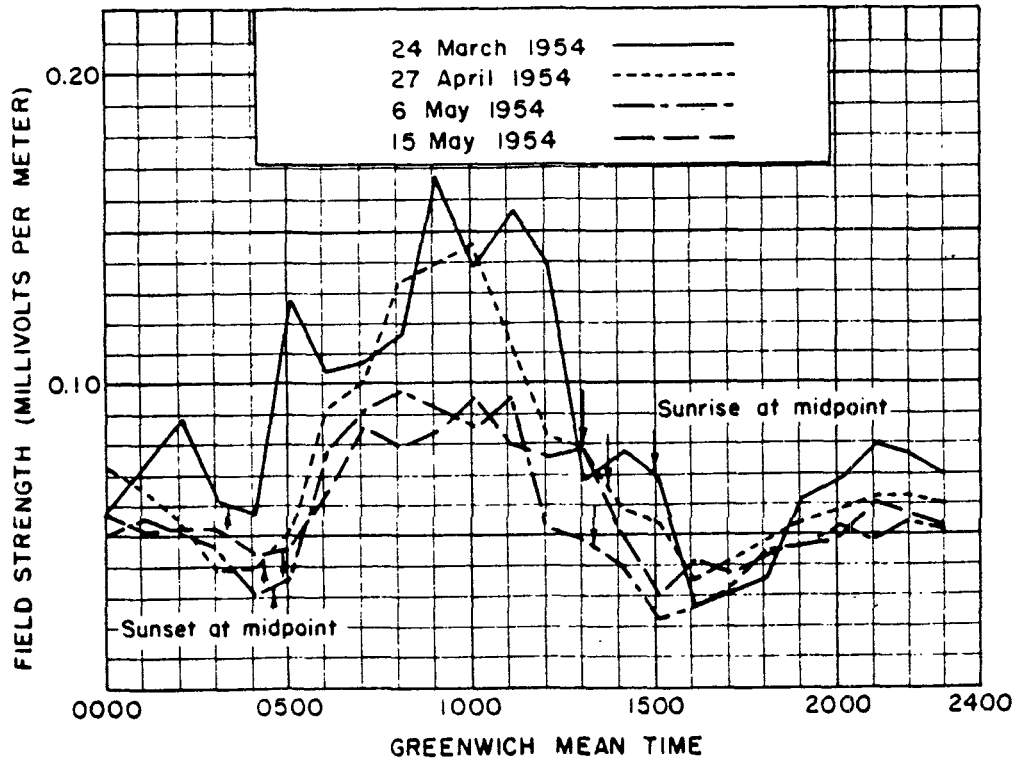

Figure 19 Plot of the field strength of NPM as measured by DRL at Thule, Greenland.

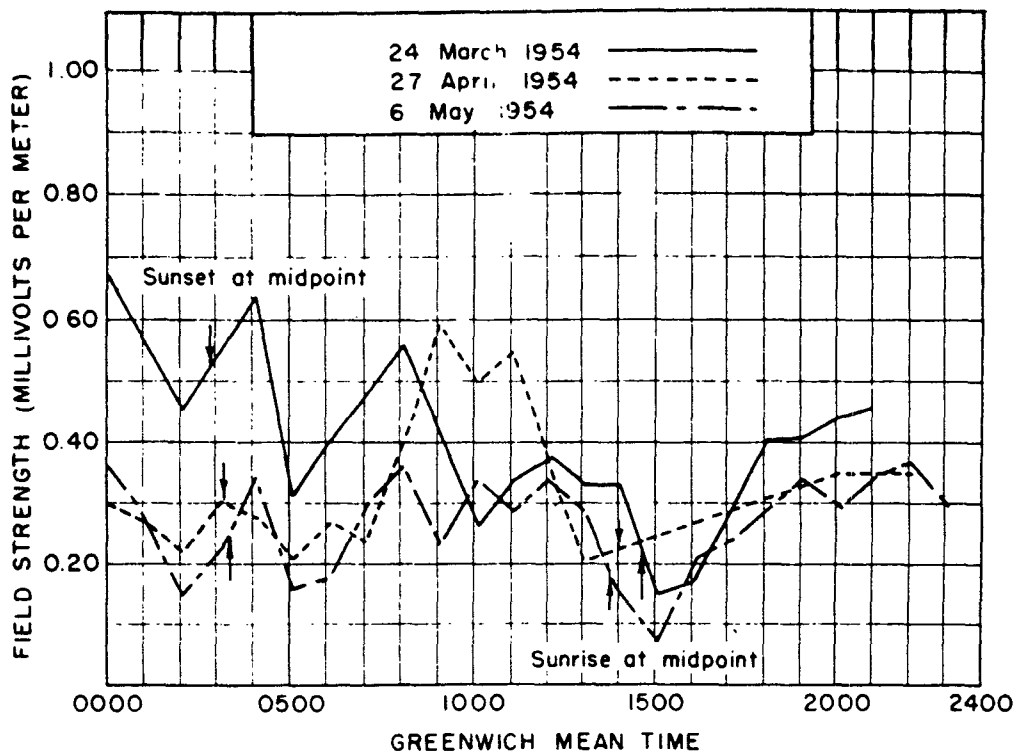

Figure 20 Plot of the field strength of NPM as measured by DRL at Austin, Texas.

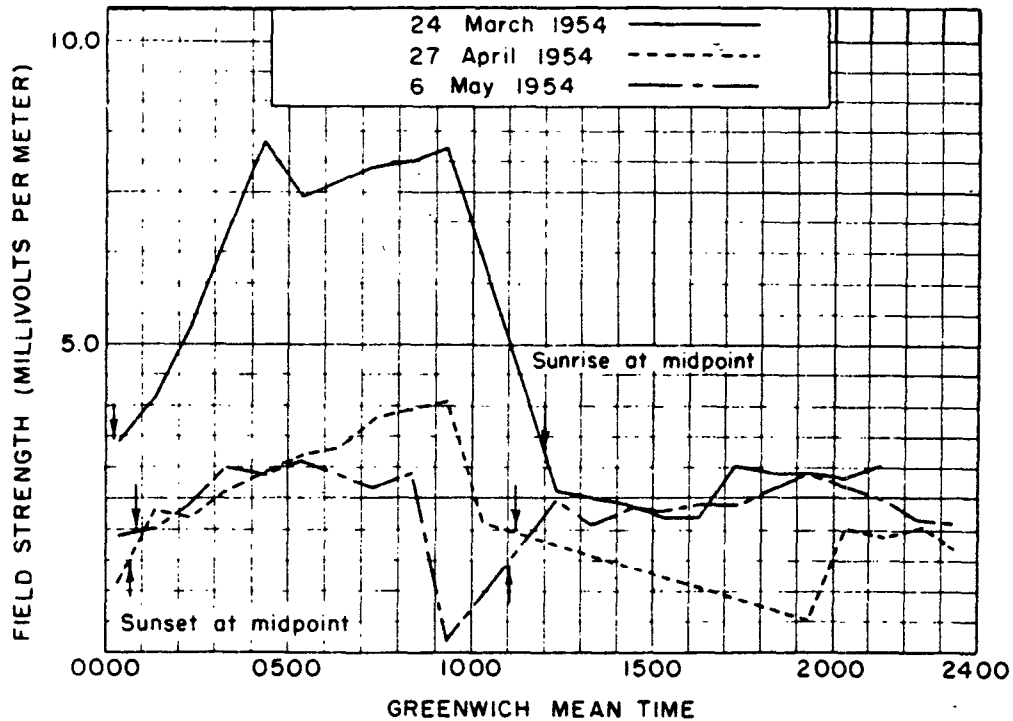

Figure 21 Plot of the field strength of NSS as measured by DRL at Austin, Texas.

agreement with other investigators over other than North Atlantic paths.

With NPM-Austin (5,800 km) as a base for predicting field strengths for NPM-Thule (7,600 km), the latter is low by 6 or 8 db. This is an apparent contradiction of most similar measurements which give greater attenuations over east-west paths, as compared with north-south paths. However, the auroral zone was not crossed in the course of those measurements.

#### CONCLUSIONS AND RECOMMENDATIONS

The first AFOAT-1 close-in (320 km) recordings of the electromagnetic pulse emitted at the time of detonation of a large nuclear device (megaton range) were made during the Castle operations. Variations in field strengths, measured with presumably identical equipment at the various locations, are not explainable. Waveforms were recorded at distances up to 12,000 km. Beyond about 2,000 to 4,000 km, close-in detail disappears. With proper corrections for path, terrain, ionospheric conditions, time of day, etc., it may be possible to make a fair estimate of yield as a function of field strength received. However, corrections to be made are imperfectly known. Frequency analysis of waveforms, together with other characteristics, may offer some assistance.

Reception and identification of nuclear-device pulses, when time of detonation is known to a millisecond, is relatively easy; doing the same thing on a 24-hour basis, when the detonation time is not known, is much more difficult. This means that more information is needed on techniques of discrimination and much of this can be learned by studying naturally-occurring atmospherics.

Studies of the various parameters affecting VLF propagation should be emphasized, and this should encompass a well-coordinated theoretical and experimental approach. Studies in VLF propagation to date have largely been concerned with communications frequencies where transmissions are repeatable. Further work along this tack in the lower portions of the band is worthwhile. In addition, further studies of naturally-occurring atmospherics should be conducted, because natural flashes have many similarities to the man-made type. The sferics studies should be extended to the low-audio frequencies and into the megacycle range---both being areas where limited work has been done so far.

## REFERENCES

1. Oleson, M.H.; Electromagnetic Effects from Atomic Explosions; Project 7.1a, Operation Tumbler-Snapper, WT-537, January 1953; AFSWP; SECRET-RESTRICTED DATA.
2. Oleson, M.H.; Electromagnetic Effects from Nuclear Explosions; Project 7.1, Operation Ivy, WT-644, 31 January 1958; AFSWP; SECRET-RESTRICTED DATA.
3. Oleson, M.H.; Electromagnetic Effects from Nuclear Explosions; Project 7.1, Operation Upshot-Knothole, WT-762, June 1955; AFSWP; SECRET-RESTRICTED DATA.
4. Kemper, John A. and others; Measurement of Electromagnetic Effects During Operation Castle; 3C106, 1 December 1954; National Bureau of Standards; SECRET-RESTRICTED DATA.
5. Quarterly Report No. 5 on Contract AF 33(600)-22582 for the period 11 December 1953 - 10 March 1954; 22 March 1954; Defense Research Laboratory, University of Texas, Austin, Texas; SECRET.
6. Static Direction Finder, AN/GRD-1A; War Department Technical Manual TM 11-2693, 28 September 1945; UNCLASSIFIED.
7. Camera, PH-557/TFH; Developer, PH-559/TFQ; Viewer, PH-558/TFP; War Department Technical Manual TM 11-2338; 2 September 1947; UNCLASSIFIED.
8. Wait, James R., and Howe, H. Herbert; Amplitude and Phase Curves for Ground-Wave Propagation in the Band 200 Cycles per Second to 500 Kilocycles; NBS Circular 574; 21 May 1956; National Bureau of Standards; UNCLASSIFIED.
9. Radio Propagation; Department of the Army Technical Manual TM 11-499; August 1950; UNCLASSIFIED.
10. Chapman, F.W., and Macario, R.C.V.; Propagation of Audio-Frequency Radio Waves to Great Distances; Nature, May 19, 1956, Vol 177, Pages 930 to 933; UNCLASSIFIED.
11. Lupton, W.H.; Electromagnetic Pulse Investigations; 5C104; 1 December 1954; National Bureau of Standards; SECRET-RESTRICTED DATA.
12. Jean, A. Glenn, and others; Supplement to Quarterly Report on Project T/506/E/NBS for Period Ending December 30, 1954; 5C106, 27 January 1955; National Bureau of Standards; SECRET.
13. McNish, A.G.; Terminal Report on Project T/420/E/NBS; 3C107, 1 November 1954; National Bureau of Standards; SECRET-RESTRICTED DATA.